

DVD Recorder

Operating Instructions

RDR-GX310



DVD + ReWritable



SHOWVIEW®

WARNING

To prevent fire or shock hazard, do not expose the unit to rain or moisture. To avoid electrical shock, do not open the cabinet. Refer servicing to qualified personnel only. The power cord (mains lead) must only be changed at a qualified service shop.



This appliance is classified as a CLASS 1 LASER product. The CLASS 1 LASER PRODUCT MARKING is located on the laser protective housing inside the enclosure.

CAUTION

The use of optical instruments with this product will increase eye hazard. As the laser beam used in this DVD recorder is harmful to eyes, do not attempt to disassemble the cabinet. Refer servicing to qualified personnel only.

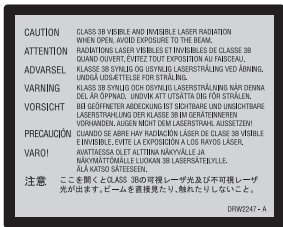

This label is located on the laser protective housing inside the enclosure.



Изготовитель:
Сони Корпорейшн

Адрес:
6-7-35 Киташинагава,
Шинагава-ку, Токио
141-0001, Япония

Страна-производитель:
Малайзия

Precautions

- This unit operates on 220 – 240 V AC, 50/60 Hz. Check that the unit's operating voltage is identical with your local power supply.
- To prevent fire or shock hazard, do not place objects filled with liquids, such as vases, on the apparatus.

SHOWVIEW is a registered trademark of Gemstar Development Corporation. The SHOWVIEW system is manufactured under license from Gemstar Development Corporation.



Disposal of Old Electrical & Electronic Equipment

This symbol is applicable only in the European Union and other European countries with separate collection systems.

Precautions

This equipment has been tested and found to comply with the limits set out in the EMC Directive using a connection cable shorter than 3 metres.

On safety

Should any solid object or liquid fall into the cabinet, unplug the recorder and have it checked by qualified personnel before operating it any further.

On power sources

- The recorder is not disconnected from the AC power source (mains) as long as it is connected to the wall outlet, even if the recorder itself has been turned off.
- If you are not going to use the recorder for a long time, be sure to disconnect the recorder from the wall outlet. To disconnect the AC power cord (mains lead), grasp the plug itself; never pull the cord.

On placement

- Place the recorder in a location with adequate ventilation to prevent heat build-up in the recorder.
- Do not place the recorder on a soft surface such as a rug that might block the ventilation holes.
- Do not place the recorder in a confined space such as a bookshelf or similar unit.
- Do not place the recorder in a location near heat sources, or in a place subject to direct sunlight, excessive dust, or mechanical shock.
- Do not place the recorder in an inclined position. It is designed to be operated in a horizontal position only.
- Keep the recorder and discs away from equipment with strong magnets, such as microwave ovens, or large loudspeakers.
- Do not place heavy objects on the recorder.

On recording

- Note that the contents of the recording cannot be compensated for under any and all conditions, including conditions that may arise due to a malfunction of this unit.
- Make trial recordings before making the actual recording.

Copyrights

- Television programmes, films, video tapes, discs, and other materials may be copyrighted. Unauthorized recording of such material may be contrary to the provisions of the copyright laws. Also, use of this recorder with cable television transmission may require authorization from the cable television transmitter and/or programme owner.
- This product incorporates copyright protection technology that is protected by U.S. patents and other intellectual property rights. Use of this copyright protection technology must be authorized by Macrovision, and is intended for home and other limited viewing uses only unless otherwise authorized by Macrovision. Reverse engineering or disassembly is prohibited.

Copy guard function

Since the recorder has a copy guard function, programmes received through an external tuner (not supplied) may contain copy protection signals (copy guard function) and as such may not be recordable, depending on the type of signal.

IMPORTANT NOTICE

Caution: This recorder is capable of holding a still video image or on-screen display image on your television screen indefinitely. If you leave the still video image or on-screen display image displayed on your TV for an extended period of time you risk permanent damage to your television screen. Plasma display panels and projection televisions are especially susceptible to this.

If you have any questions or problems concerning your recorder, please consult your nearest Sony dealer.

About this manual

- In this manual, “disc” is used as a general reference for the DVDs or CDs unless otherwise specified by the text or illustrations.
- Instructions in this manual describe the controls on the remote. You can also use the controls on the recorder if they have the same or similar names as those on the remote.
- The on-screen display illustrations used in this manual may not match the graphics displayed on your TV screen.
- The explanations regarding DVDs in this manual refer to DVDs created on this recorder. The explanations do not apply to DVDs that are created on other recorders and played back on this recorder.

Table of Contents

WARNING	2
Precautions	2
Ways to Use Your DVD Recorder	7
Quick Guide to Disc Types	8
Recordable and playable discs	8
Playable discs	10

Hookups and Settings 12

Hooking Up the Recorder	12
Step 1: Unpacking	12
Step 2: Connecting the Aerial Cable	13
Step 3: Connecting the Video Cords	14
Using the PROGRESSIVE button	15
Step 4: Connecting the Audio Cords	16
Step 5: Connecting the Power Cord (Mains Lead)	17
Step 6: Preparing the Remote	18
Controlling TVs with the remote	18
Controlling the volume of your AV amplifier (receiver) with the remote	19
If you have a Sony DVD player or more than one Sony DVD recorder	20
Step 7: Easy Setup	21
Connecting a VCR or Similar Device	22
Connecting to the LINE IN 1 or 3 jacks	22
Connecting to the LINE 2 IN jacks on the front panel	23
Connecting to a Satellite or Digital Tuner	24

Seven Basic Operations — Getting to Know Your DVD Recorder

1. Inserting and Formatting a DVD Disc (Disc Info)	25
Inserting a Disc	25
Formatting a DVD disc (Disc Info)	25
2. Recording a Programme	27
Checking the disc status while recording	27
3. Playing the Recorded Programme (Title List)	28
4. Displaying the Playing Time and Play Information	30
Checking the playing/remaining time	31
5. Changing the Name of a Recorded Programme	32
6. Labelling and Protecting a Disc	33
Labelling a disc	33
Protecting a disc	34
7. Playing the Disc on Other DVD Equipment (Finalize)	34
Unfinalizing a disc	35

Timer Recording	36
Before Recording	36
Recording mode	36
Recording stereo and bilingual programmes	36
Unrecordable pictures	37
Timer Recording (Standard/ShowView)	37
Setting the timer manually (Standard)	37
Recording TV programmes using the ShowView system	39
Using the Quick Timer function	40
Adjusting the recording picture quality and size	40
Creating chapters in a title	41
Checking/Changing/Canceling Timer Settings (Timer List)	42
Recording From Connected Equipment	43
Recording from connected equipment with a timer (Synchro Rec)	43
Recording from connected equipment without a timer	45

Playback	46
Playing	46
Playback options	48
Adjusting the picture quality	50
Adjusting the sound quality	50
Playing from the beginning of the programme you are recording (Chasing Playback)	51
Playing a previous recording while making another (Simultaneous Rec and Play)	51
Searching for a Title/Chapter/Track, etc.	52
Searching by Thumbnail (Visual Search)	52
Searching by title number or time code	52
Playing MP3 Audio Tracks or JPEG Image Files	53
Selecting an MP3 album or track	53
Selecting a JPEG album or image	54
About MP3 audio tracks and JPEG image files	55
MP3 audio tracks or JPEG image files that the recorder can play	55
About playback order of albums, tracks, and files	56

Erasing and Editing	57
Before Editing	57
Edit options for DVD-RWs (VR mode)	57
Edit options for DVD+RWs/DVD-RWs (Video mode)/DVD+Rs/DVD-Rs	58
Erasing and Editing a Title	58
Erasing a chapter (Delete Chapter)	59
Erasing a section of a title (A-B Erase)	59
Erasing multiple titles (Erase Titles)	60
Erasing all titles on the disc	60
Erasing titles to open up disc space (Disc Map)	60
Creating chapters manually	61
Creating and Editing a Playlist	61
Moving a Playlist title (Change Order)	62
Combining multiple Playlist titles (Combine)	63
Dividing a Playlist title (Divide)	63

DV Dubbing	64
Before DV Dubbing	64
Preparing for DV dubbing	64
Recording an Entire DV Format Tape (One Touch Dubbing)	65
Program Edit	66
<hr/>	
Settings and Adjustments	68
Aerial Reception and Language Settings (Settings)	68
Channel Setting	68
Channel List (Changing/Disabling the channels)	70
TV Guide Page	71
Clock	71
Language	72
Video Settings (Video)	72
Audio Settings (Audio)	74
Recording and Parental Control Settings (Features)	76
Disc and Remote Control Settings/Factory Settings (Options)	78
Easy Setup (Resetting the Recorder)	79
<hr/>	
Additional Information	80
Troubleshooting	80
Self-diagnosis Function (When letters/numbers appear in the display)	84
Notes About This Recorder	85
Specifications	86
About i.LINK	87
Guide to Parts and Controls	88
Glossary	92
Language Code List	94
Area Code	94
Index	95

Ways to Use Your DVD Recorder

Recording/Playback

Compatible media and reference pages

Quick access to recorded titles
– Title List



+RW **-RWVR** **-RW_{video}** **+R** **-R**

“3. Playing the Recorded Programme (Title List)” on page 28

Play the beginning of a title
while it is being recorded
– Chasing Playback



-RWVR

“Playing from the beginning of the programme you are recording (Chasing Playback)” on page 51

Watching one title while
recording another
– Simultaneous Rec and Play



+RW **-RWVR** **-RW_{video}** **+R** **-R** **VCD**
CD **DATA DVD** **DATA CD**

“Playing a previous recording while making another (Simultaneous Rec and Play)” on page 51

Dubbing/Editing

Compatible media and reference pages

Creating your own programme
– Playlist



-RWVR

“Creating and Editing a Playlist” on page 61

Automatic dubbing of DV tapes
– DV Dubbing

















+RW **-RWVR** **-RW_{video}** **+R** **-R**

“DV Dubbing” on page 64

A list of recordable and playable discs is on page 8.

Quick Guide to Disc Types

Recordable and playable discs

Type	Disc Logo	Icon used in this manual	Formatting (new discs)	Compatibility with other DVD players (finalizing)
DVD+RW	 DVD+ReWritable  DVD+ReWritable		Automatically formatted in +VR mode	Playable on DVD+RW compatible players (automatically finalized)
DVD-RW	 DVD-RW		Format in VR mode (page 25)	Playable only on VR mode compatible players (finalization unnecessary)
	 DVD-RW 		Format in Video mode (page 25)	Playable on most DVD players (finalization necessary) (page 34)
DVD+R	 DVD+R		Automatically formatted	Playable on most DVD players (finalization necessary) (page 34)
DVD+R DL	 DVD+R DL		Automatically formatted	Playable on most DVD players (finalization necessary) (page 34)
DVD-R	 DVD-R 4.7		Automatically formatted	Playable on most DVD players (finalization necessary) (page 34)

Usable disc versions (as of March 2005)

- 8x-speed or slower DVD+RWs
- 6x-speed or slower DVD-RWs (Ver.1.1, Ver.1.2 with CPRM^{*1})
- 16x-speed or slower DVD+Rs
- 16x-speed or slower DVD-Rs (Ver.2.0, Ver.2.1)
- 2.4x-speed DVD+R DL (Double Layer) discs

“DVD+RW,” “DVD-RW,” “DVD+R,” “DVD+R DL,” and “DVD-R” are trademarks.

^{*1} CPRM (Content Protection for Recordable Media) is a coding technology that protects copyrights for images.

^{*2} This logo applies to 4x and 6x speed DVD-RW discs.

	Recording Features				Editing Features			
	Rewrite (page 36)	Auto Chapter (page 76)	Manual Chapter (page 61)	Record 16:9 sizes (page 40)	Change title name (page 58)	Delete title (page 60)	A-B Erase (page 59)	Playlist (page 61)
	Yes	Yes	No	No	Yes	Yes	Yes	No
	Yes	Yes	Yes	Yes	Yes	Yes	Yes	Yes
	Yes	Yes	No	Yes ^{*3}	Yes	Yes	No	No
	No	Yes	No	No	Yes	Yes ^{*4}	No	No
	No	Yes	No	Yes ^{*3}	Yes	Yes ^{*4}	No	No









Discs that cannot be recorded on

- 8 cm discs
- DVD-Rs in VR mode (Video Recording format)

^{*3} Only if the recording mode is LSP, SP, HSP, or HQ, and “DVD Rec. Picture Size” is set to “16:9.”

^{*4} Erasing titles does not free up disc space.

Playable discs

Type	Disc Logo	Icon used in this manual	Characteristics
DVD VIDEO			Discs such as movies that can be purchased or rented
VIDEO CD			VIDEO CDs or CD-Rs/CD-RWs in VIDEO CD/Super VIDEO CD format
CD			Music CDs or CD-Rs/CD-RWs in music CD format that can be purchased
DATA DVD	—		DVD+RWs/DVD+Rs/DVD-RWs/DVD-Rs/DVD-ROMs containing JPEG image files
DATA CD	—		CD-ROMs/CD-Rs/CD-RWs containing MP3 audio tracks or JPEG image files
8 cm DVD+RW/ DVD-RW/DVD-R	—	—	8 cm DVD+RW, DVD-RW, and DVD-R recorded with a DVD video camera. (Still images recorded with a DVD video camera cannot be played.)

“DVD VIDEO” and “CD” are trademarks.

Discs that cannot be played

- PHOTO CDs
- CD-ROMs/CD-Rs/CD-RWs that are not recorded in music CD or Video CD format, or do not contain MP3 or JPEG files
- Data part of CD-Extras
- DVD-ROMs that do not contain JPEG files or are not in DVD Video format
- DVD Audio discs
- DVD-RAMs
- HD layer on Super Audio CDs
- DVD VIDEOS with a different region code (page 11)
- DVD-Rs recorded in VR mode (Video Recording format)

Maximum recordable number of titles

Disc	Number of titles*
DVD-RW/DVD-R	99
DVD+RW/DVD+R	49
DVD+R DL	49

* The maximum length for each title is eight hours.

Note on playback operations of DVD VIDEOS/VIDEO CDs

Some playback operations of DVD VIDEOS/VIDEO CDs may be intentionally set by software producers. Since this recorder plays DVD VIDEOS/VIDEO CDs according to the disc contents the software producers designed, some playback features may not be available. Also, see the instructions supplied with the DVD VIDEOS/VIDEO CDs.

Region code (DVD VIDEO only)

Your recorder has a region code printed on the rear of the unit and will only play DVD VIDEOS (playback only) labelled with identical region codes. This system is used to protect copyrights. DVD VIDEOS labelled  will also play on this recorder.

If you try to play any other DVD VIDEO, the message “Playback prohibited by region code.” will appear on the TV screen. Depending on the DVD VIDEO, no region code indication may be labelled even though playing the DVD VIDEO is prohibited by area restrictions.



Music discs encoded with copyright protection technologies

This product is designed to play back discs that conform to the Compact Disc (CD) standard. Recently, various music discs encoded with copyright protection technologies are being marketed by some record companies. Please be aware that among those discs, there are some that do not conform to the CD standard and may not be playable by this product.

Note on DualDiscs

A DualDisc is a two sided disc product which mates DVD recorded material on one side with digital audio material on the other side. However, since the audio material side does not conform to the Compact Disc (CD) standard, playback on this product is not guaranteed.

Notes

- Some DVD+RWs/DVD+Rs, DVD-RWs/DVD-Rs, or CD-RWs/CD-Rs cannot be played on this recorder due to the recording quality or physical condition of the disc, or the characteristics of the recording device and authoring software. The disc will not play if it has not been correctly finalized. For more information, see the operating instructions for the recording device.
- You cannot mix VR mode and Video mode on the same DVD-RW. To change the disc's format, reformat the disc (page 25). Note that the disc's contents will be erased after reformatting.
- You cannot shorten the time required for recording even with high-speed discs.
- It is recommended that you use discs with “For Video” printed on their packaging.
- You cannot add new recordings to DVD+Rs, DVD-Rs, or DVD-RWs (Video mode) that contain recordings made on other DVD equipment.
- In some cases, you may not be able to add new recordings to DVD+RWs that contain recordings made on other DVD equipment. If you do add a new recording, note that this recorder will rewrite the DVD menu.
- You cannot edit recordings on DVD+RWs, DVD-RWs (Video mode), DVD+Rs, or DVD-Rs that are made on other DVD equipment.
- If the disc contains PC data unrecognizable by this recorder, the data may be erased.
- You may not be able to record on some recordable discs, depending on the disc.

Hooking Up the Recorder

Follow steps 1 to 7 to hook up and adjust the settings of the recorder.

Notes

- Plug cords securely to prevent unwanted noise.
- Refer to the instructions supplied with the components to be connected.
- You cannot connect this recorder to a TV that does not have a video input jack.
- Be sure to disconnect the power cord (mains lead) of each component before connecting.

Step 1: Unpacking

Check that you have the following items:

- Audio/video cord (phono plug × 3 ↔ phono plug × 3) (1)
- Power cord (mains lead) (1)
- Aerial cable (1)
- Remote commander (remote) (1)
- R6 (size AA) batteries (2)

Step 2: Connecting the Aerial Cable

Connect the aerial cable by following the steps below. Do not connect the power cord (mains lead) until you reach “Step 5: Connecting the Power Cord (Mains Lead)” on page 17.

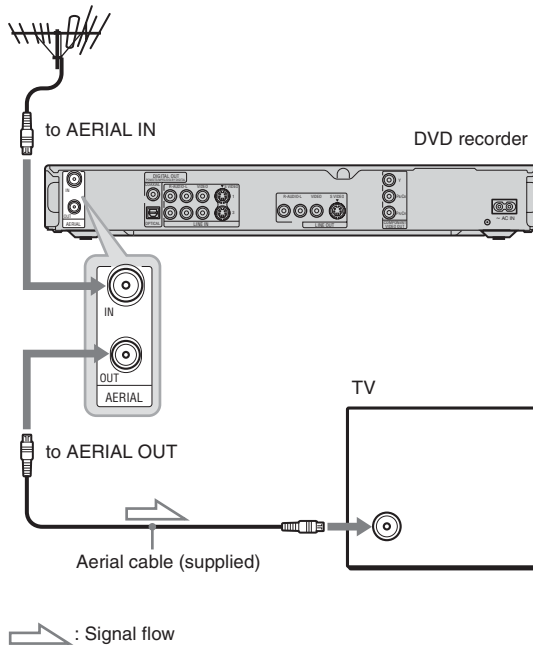

- 1** Disconnect the aerial cable from your TV and connect it to AERIAL IN on the rear panel of the recorder.
- 2** Connect AERIAL OUT of the recorder to the aerial input of your TV, using the supplied aerial cable.

Step 3: Connecting the Video Cords

Select one of the following patterns **A** through **C**, according to the input jack on your TV monitor, projector, or AV amplifier (receiver). This will enable you to view pictures.

A Connecting to a video input jack

You will enjoy standard quality images.

B Connecting to an S VIDEO input jack

You will enjoy high quality images.

C Connecting to component video input jacks (Y, Pb/Cb, Pr/Cr)

You will enjoy accurate colour reproduction and high quality images.

If your TV accepts progressive 525p/625p format signals, you must use this connection. Then press PROGRESSIVE on the remote to send progressive video signals. For details, see “Using the PROGRESSIVE button” on page 15.

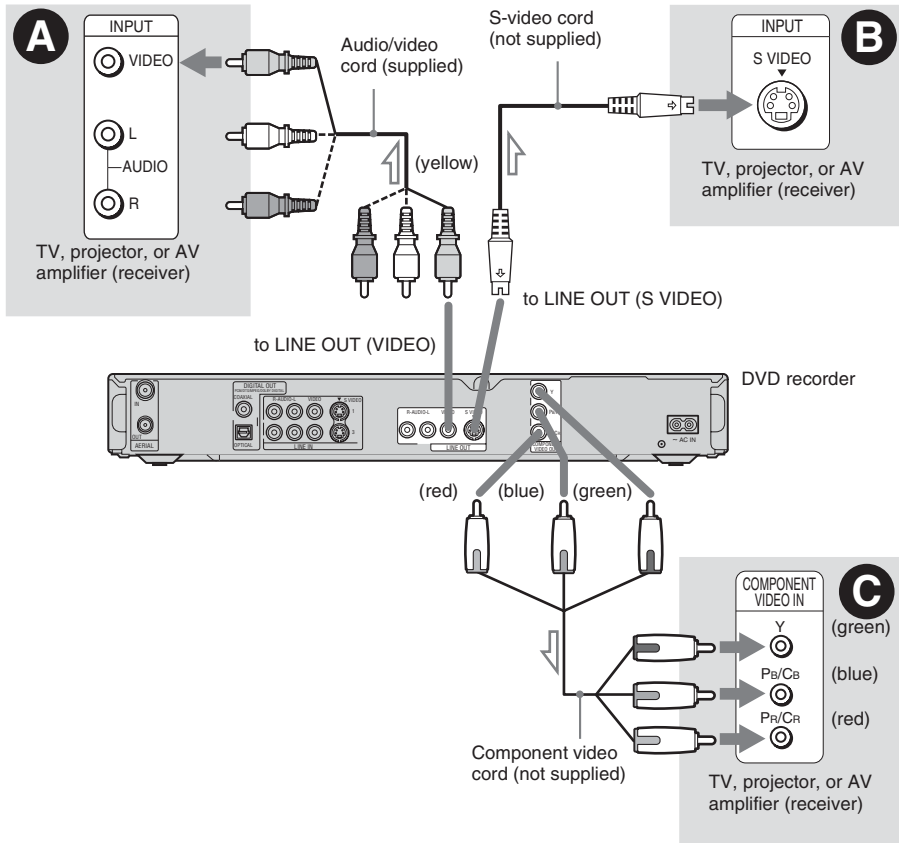

 : Signal flow

When playing “wide screen” images

Some recorded images may not fit your TV screen. To change the picture size, see page 72.

If you are connecting to a VCR

Connect your VCR to the LINE IN jack on the recorder (page 22).

Notes

- Do not connect more than one type of video cord between the recorder and your TV at the same time.
- You cannot use the PROGRESSIVE button with the connections **A** and **B**.

Using the PROGRESSIVE button

By using the PROGRESSIVE button, you can select the signal format in which the recorder outputs video signals: interlace or progressive.

- 1 Connect the recorder using the COMPONENT VIDEO OUT jacks (pattern  on page 14).
- 2 Press the PROGRESSIVE button. “PROGRESSIVE” appears in the front panel display when the recorder outputs progressive signals.

◆ Progressive

Select this when:

- your TV accepts progressive signals, and,
- the TV is connected to the COMPONENT VIDEO OUT jacks.

Note that the pictures will not be clear or no picture will appear if you select progressive signal output when either of the above conditions is not met.

◆ Interlace

Set to this position when:

- your TV does not accept progressive signals, or,
- your TV is connected to jacks other than the COMPONENT VIDEO OUT jacks (LINE OUT (VIDEO or S VIDEO)).

Hint

When you select progressive signal output, you can fine-tune the signal according to the type of software you are watching (page 73).

Step 4: Connecting the Audio Cords

Select one of the following patterns **A** or **B**, according to the input jack on your TV monitor, projector, or AV amplifier (receiver). This will enable you to listen to sound.

A Connecting to audio L/R input jacks

This connection will use your TV's or stereo amplifier's (receiver's) two speakers for sound. You can enjoy the following surround effects (page 48).

- TV: Dynamic, Wide, Night
- Stereo amplifier (receiver): Standard, Night

B Connecting to a digital audio input jack

If your AV amplifier (receiver) has a Dolby[®]*1 Digital, DTS[®]*2, or MPEG audio decoder and a digital input jack, use this connection. You can enjoy Dolby Digital (5.1ch), DTS (5.1ch), and MPEG audio (5.1ch) surround effects.

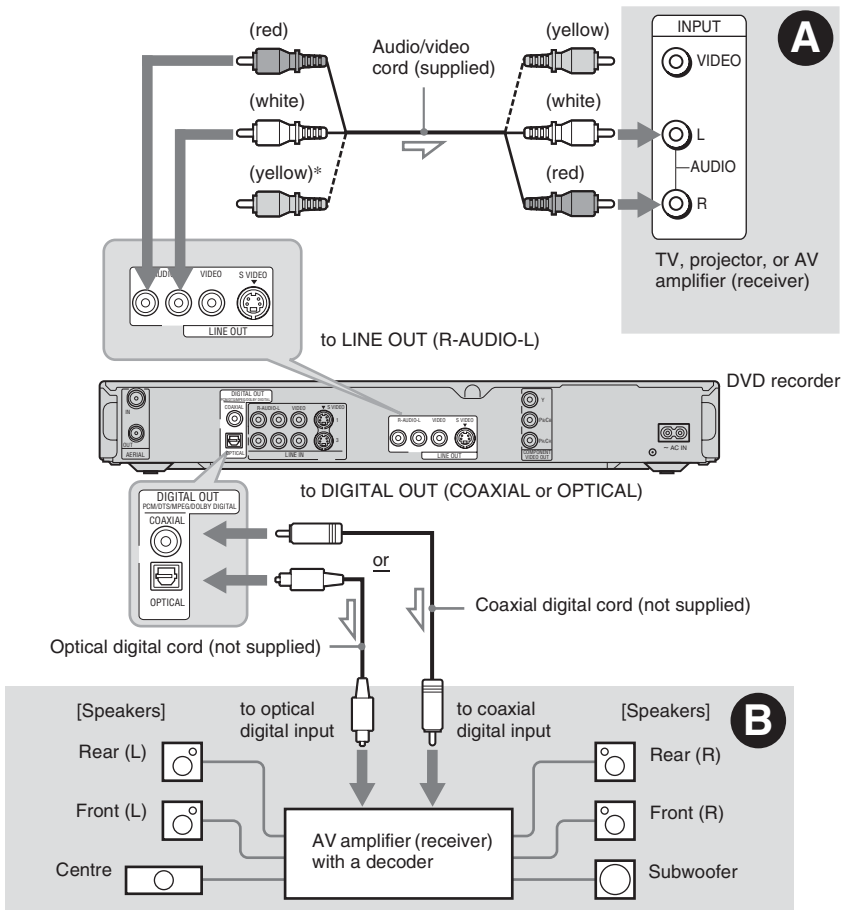

* The yellow plug is used for video signals (page 14).

Hint

For correct speaker location, see the operating instructions supplied with the connected components.

Notes

- Do not connect your TV's audio output jacks to the LINE IN (R-AUDIO-L) jacks at the same time. This will cause unwanted noise to come from your TV's speakers.
- In the connection **A**, do not connect the LINE IN (R-AUDIO-L) and LINE OUT (R-AUDIO-L) jacks to your TV's audio output jacks at the same time. This will cause unwanted noise to come from your TV's speakers.
- In the connection **B**, after you have completed the connection, make the appropriate settings under "Audio Connection" in "Easy Setup" (page 21). Otherwise, no sound or a loud noise will come from your speakers.
- With the connection **B**, the surround sound effects of this recorder cannot be used.

*1 Manufactured under license from Dolby Laboratories. "Dolby," and the double-D symbol are trademarks of Dolby Laboratories.

*2 "DTS" and "DTS Digital Out" are trademarks of Digital Theater Systems, Inc.

Step 5: Connecting the Power Cord (Mains Lead)

Connect the supplied power cord (mains lead) to the AC IN terminal of the recorder. Then plug the recorder and TV power cords (mains leads) into the mains. After you connect the power cord (mains lead), **you must wait for a short while before operating the recorder.** You can operate the recorder once the front panel display lights up and the recorder enters standby mode. If you connect additional equipment to this recorder (page 22), be sure to connect the power cord (mains lead) after all connections are complete.

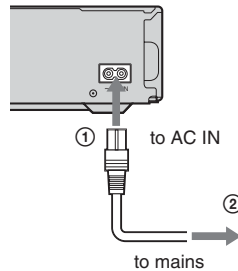

Step 6: Preparing the Remote

You can control the recorder using the supplied remote. Insert two R6 (size AA) batteries by matching the ⊕ and ⊖ ends on the batteries to the markings inside the battery compartment. When using the remote, point it at the remote sensor  on the recorder.

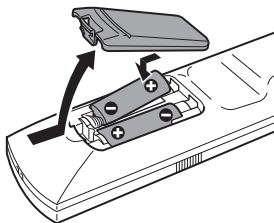

Notes

- If the supplied remote interferes your other Sony DVD recorder or player, change the command mode number for this recorder (page 20).
- Use the batteries correctly to avoid possible leakage and corrosion. Do not touch the liquid with bare hands should leakage occur. Observe the following:
 - Do not use a new battery with an old battery, or batteries of different manufacturers.
 - Do not attempt to recharge the batteries.
 - If you do not intend to use the remote for an extended period of time, remove the batteries.
 - If battery leakage occurs, wipe out any liquid inside the battery compartment, and insert new batteries.
- Do not expose the remote sensor (marked  on the front panel) to strong light, such as direct sunlight or lighting apparatus. The recorder may not respond to the remote.

Controlling TVs with the remote

You can adjust the remote's signal to control your TV.

If you connected the recorder to an AV amplifier (receiver), you can use the supplied remote to control the AV amplifier's (receiver's) volume.

Notes

- Depending on the connected unit, you may not be able to control your TV or AV amplifier (receiver) with some or all of the buttons below.
- If you enter a new code number, the code number previously entered will be erased.
- When you replace the batteries of the remote, the code number may be reset to the default setting. Set the appropriate code number again.

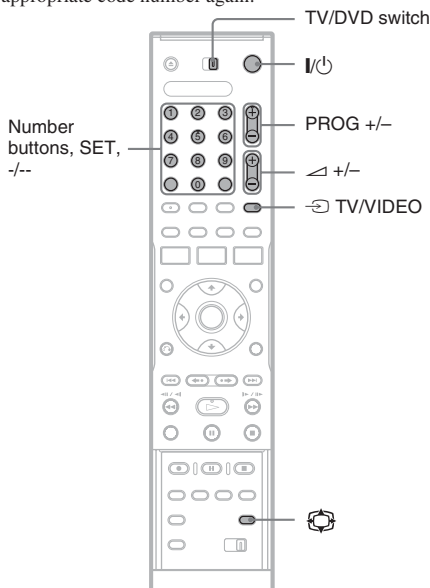

- 1** Slide the TV/DVD switch to TV.
- 2** Hold down I/⏻.
- 3** Enter your TV's manufacturer code (see "Code numbers of controllable TVs" below) using the number buttons.

4 Release I/⏻.

When the TV/DVD switch is set to TV, the remote performs the following:

Buttons	Operations
I/⏻	Turns your TV on or off
◀ (volume) +/-	Adjusts the volume of your TV
PROG +/-	Selects the programme position on your TV
⊞ (wide mode)	Switches to or from the wide mode of a Sony wide-screen TV
↺ TV/VIDEO	Switches your TV's input source
Number buttons and SET, -/--*	Selects the programme position on your TV

* If you use the number buttons to select the TV's programme position, press -/-- followed by the number buttons for two-digit numbers.

Code numbers of controllable TVs

If more than one code number is listed, try entering them one at a time until you find the one that works with your TV.

Manufacturer	Code number
Sony	01 (default)
Aiwa	01 (default)
Grundig	11
Hitachi	23, 24, 72
Loewe	06, 45
Nokia	15, 16, 69, 73
Panasonic	17, 49
Philips	06, 07, 08, 23, 45, 72
Saba	12, 13, 36, 43, 74, 75
Samsung	06, 22, 23, 71, 72
Sanyo	25
Sharp	29
Telefunken	12, 13, 36, 43, 74, 75
Thomson	12, 13, 43, 74, 75
Toshiba	38
LG	06
JVC	33

Controlling the volume of your AV amplifier (receiver) with the remote

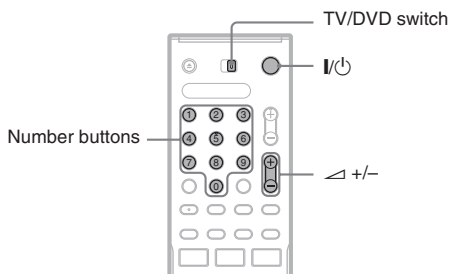

- 1 Slide the TV/DVD switch to DVD.
- 2 Hold down I/⏻, and enter the manufacturer code (see the table below) for your AV amplifier (receiver) using the number buttons.
- 3 Release I/⏻.

The ◀ (volume) +/- buttons control the AV amplifier's volume.

If you want to control the TV's volume, slide the TV/DVD switch to TV.

⚙️ Hint

If you want to control the TV's volume even when the TV/DVD switch is set to DVD, repeat the steps above and enter the code number 90 (default).

Code numbers of controllable AV amplifiers (receivers)

If more than one code number is listed, try entering them one at a time until you find the one that works with your AV amplifier (receiver).

Manufacturer	Code number
Sony	78, 79, 80, 91
Denon	84, 85, 86
Kenwood	92, 93
Onkyo	81, 82, 83
Pioneer	99
Sansui	87
Technics	97, 98
Yamaha	94, 95, 96

If you have a Sony DVD player or more than one Sony DVD recorder

If the supplied remote interferes with your other Sony DVD recorder or player, set the command mode number for this recorder and the supplied remote to one that differs from the other Sony DVD recorder or player.

The default command mode setting for this recorder and the supplied remote is DVD3.

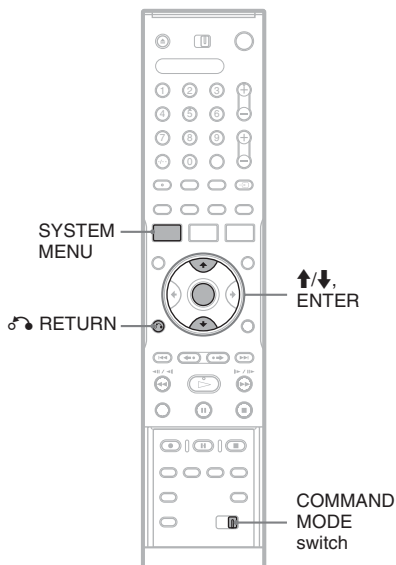

- 1** Press **SYSTEM MENU**.
The System Menu appears.
- 2** Select **"SETUP,"** and press **ENTER**.

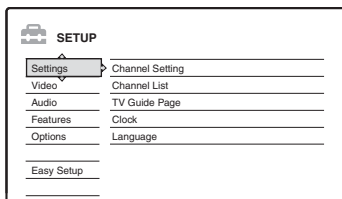

- 3** Select **"Options,"** and press **ENTER**.

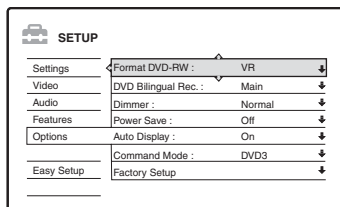

- 4** Select **"Command Mode,"** and press **ENTER**.

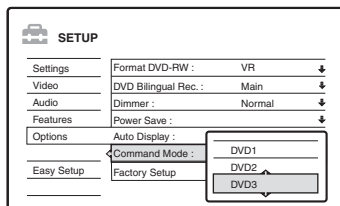

- 5** Select the **Command mode (DVD1, DVD2, or DVD3),** and press **ENTER**.

- 6** Slide the **COMMAND MODE** switch on the remote so it matches the mode you selected above.

To return to the previous step

Press **RETURN**.

Check that the command mode switch on the remote is set to the default setting of DVD3 before you try to change the command mode for the recorder. If the command mode for the remote is changed to DVD1 or DVD2, you may be unable to operate this recorder.

Step 7: Easy Setup

Make the basic adjustments by following the on-screen instructions in “Easy Setup.”

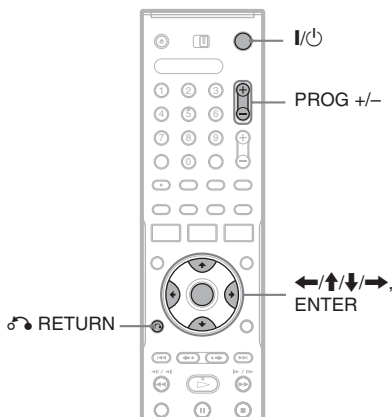

1 Turn on the recorder and switch the input selector on your TV so that the signal from the recorder appears on your TV screen.

The message about the initial settings appears.

- If this message does not appear, select “Easy Setup” from “SETUP” in the System Menu to run “Easy Setup” function (“Settings and Adjustments” on page 68).

2 Press ENTER.

Follow the on-screen instructions to make the following settings.

◆ OSD

Select the language for the on-screen displays.

◆ Tuner System

Select “ELSE-English,” regardless of your area of language.

The programme position order will be set.

To set the programme positions manually, see page 68.

◆ Clock

Set the clock manually using $\leftarrow/\uparrow/\downarrow/\rightarrow$, and press ENTER.

◆ TV Type

If you have a wide-screen TV, select “16:9.”
If you have a standard TV, select either “4:3 Letter Box” (shrink to fit) or “4:3 Pan Scan” (stretch to fit). This will determine how “wide-screen” images are displayed on your TV.

◆ Audio Connection

If you connected an AV amplifier (receiver) using either a digital optical or coaxial cord, select “Yes: DIGITAL OUT” and set the digital output signal (page 75).

3 Press ENTER when “Finish” appears. “Easy Setup” is finished.

To return to the previous step

Press \curvearrowright RETURN.

💡 Hints

- If your AV amplifier (receiver) has an MPEG audio decoder, set “MPEG” to “MPEG” (page 75).
- If you want to run “Easy Setup” again, select “Easy Setup” from “SETUP” in the System Menu (page 79).

Connecting a VCR or Similar Device

After disconnecting the recorder's power cord (mains lead) from the mains, connect a VCR or similar recording device to the LINE IN jacks of this recorder. Use the DV IN jack on the front panel if the equipment has a DV output jack (i.LINK jack) (page 64). See also the instruction manual supplied with the connected equipment. To record on this recorder, see "Recording from connected equipment without a timer" on page 45.

Connecting to the LINE IN 1 or 3 jacks

Connect a VCR or similar recording device to the LINE IN 1 or 3 of this recorder. If the equipment has an S-video jack, you can use an S-video cord instead of an audio/video cord.

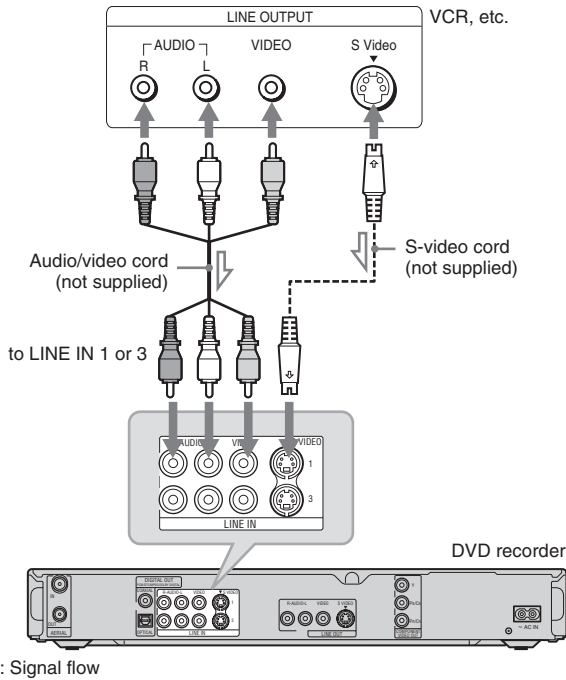

Notes

- Pictures containing copy protection signals that prohibit any copying cannot be recorded.
- If you pass the recorder signals via the VCR, you may not receive a clear image on your TV screen.



Be sure to connect your VCR to the DVD recorder and your TV in the order shown below. To watch video tapes, watch the tapes through a second line input on your TV.

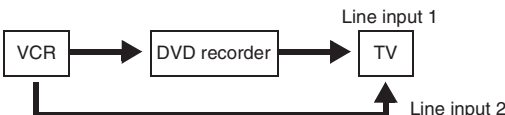

- If you disconnect the recorder's power cord (mains lead), you will not be able to view the signals from the connected VCR.

Connecting to the LINE 2 IN jacks on the front panel

Connect a VCR or similar recording device to the LINE 2 IN jacks of this recorder. If the equipment has an S-video jack, you can use an S-video cord instead of an audio/video cord.

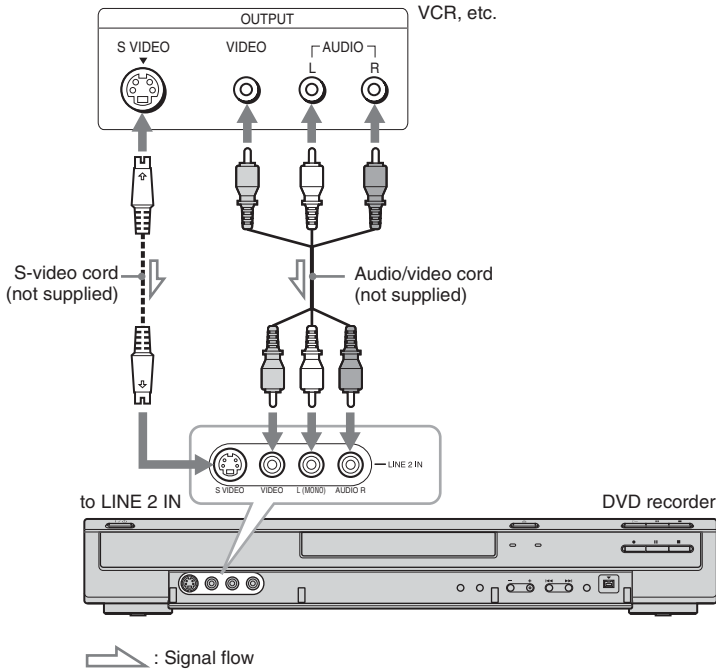

Hint

When the connected equipment outputs only monaural sound, connect to just the L (MONO) and VIDEO input jacks on the front of the recorder. Do not connect the R input jack.

Notes

- Do not connect the yellow LINE IN (VIDEO) jack when using an S-video cord.
- Do not connect the output jack of this recorder to another equipment's input jack with the other equipment's output jack connected to the input jack of this recorder. Noise (feedback) may result.
- Do not connect more than one type of video cord between the recorder and your TV at the same time.

Connecting to a Satellite or Digital Tuner

Connect a satellite or digital tuner to this recorder using the LINE IN 1 jacks. Disconnect the recorder's power cord (mains lead) from the mains when connecting the tuner. To use the Synchro-Rec function, see below.

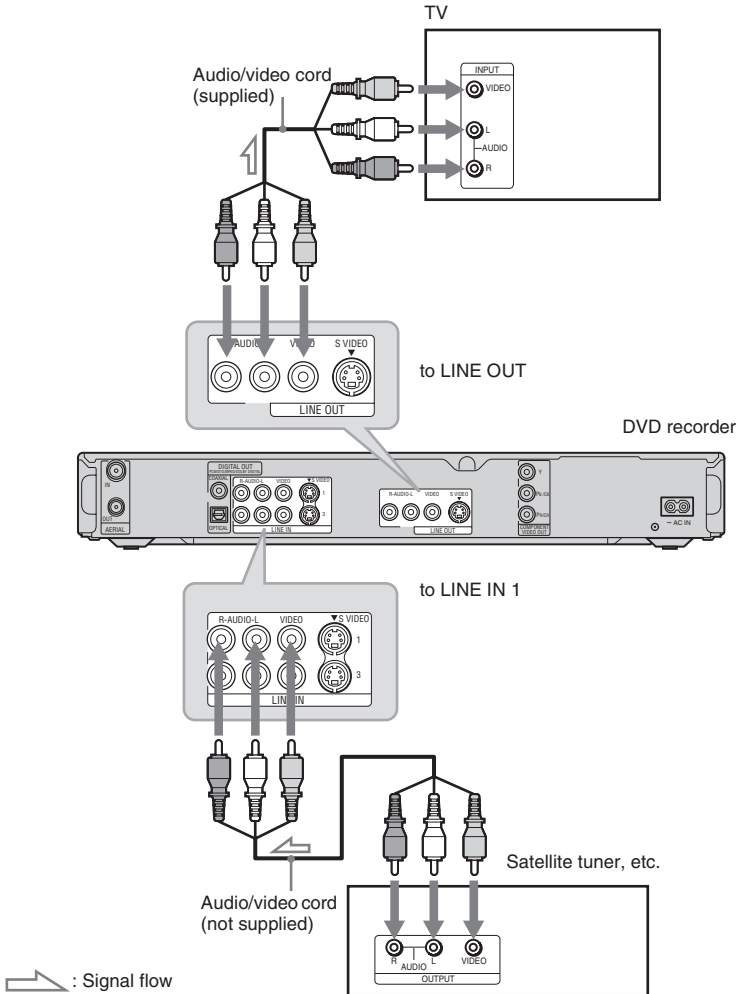

If you want to use the Synchro Rec function

This connection is necessary to use the Synchro-Recording function. See "Recording from connected equipment with a timer (Synchro Rec)" on page 43.

Notes

- Synchro-Recording does not work with some tuners. For details, see the tuner's operating instructions.
- If you disconnect the recorder's power cord (mains lead), you will not be able to view the signals from the connected tuner.

1. Inserting and Formatting a DVD Disc (Disc Info)

Inserting a Disc

+RW -RWVR -RWVideo +R -R DVD
VCD CD DATA DVD DATA CD

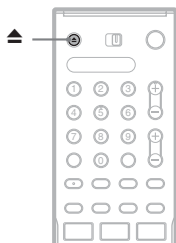

- 1 Press (open/close), and place a disc on the disc tray.



With the recording/playing side facing down

- 2 Press (open/close) to close the disc tray.

Wait until “LOAD” disappears from the front panel display.
Unused DVDs are formatted automatically.

Formatting a DVD disc (Disc Info)

+RW -RWVR -RWVideo

New discs are automatically formatted when inserted. If necessary, you can manually re-format a DVD+RW or DVD-RW disc to make a blank disc. For DVD-RWs, you can select a recording format (VR mode or Video mode) according to your needs (page 8).

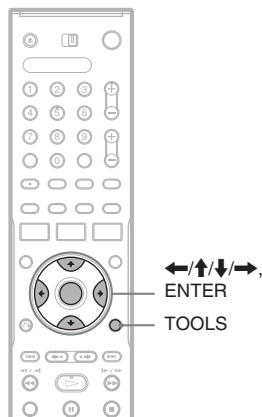

- 1 Insert a disc.
See “Inserting a Disc” on page 25.
- 2 Press **TOOLS**.
The **TOOLS** menu appears.

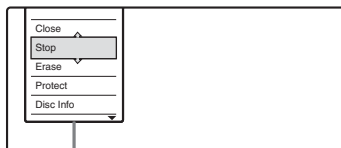

Options for the disc or picture

The **TOOLS** menu displays options applicable to the entire disc (e.g. disc protection), recorder (e.g. audio settings during recording), or multiple items on a list menu (e.g. erasing multiple titles). The displayed options differ depending on the situation and disc type.

3 Move the cursor down the **TOOLS** menu until “Disc Info” is selected, and press **ENTER**.

Example: When a DVD-RW (VR mode) is inserted.

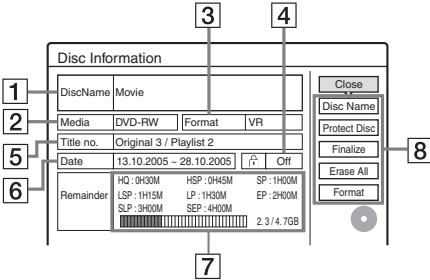

- 1 “Disc Name” (DVD only)
- 2 “Media”: Disc type
- 3 “Format”: Recording format type (DVD-RW only)
- 4 “On”/“Off”: Indicates whether protection is set (DVD-RW in VR mode only)
- 5 “Title no.”: Total number of titles
- 6 “Date”: Dates of when the oldest and the most recent titles were recorded (DVD only)
- 7 “Continuous Rem. Time”/“Remainder” (approximate)
 - The remaining recording time in each of the recording modes
 - Disc space bar
 - Remaining disc space/total disc space
- 8 Disc setting buttons
 - “Disc Name” (page 33)
 - “Protect Disc” (page 34)
 - “Finalize”/“Unfinalize” (page 34)
 - “Erase All” (page 60)
 - “Format”

Available settings differ depending on the disc type.

4 Select “Format,” and press **ENTER**.

5 Select “OK,” and press **ENTER**.

For DVD-RWs, select “VR” or “Video,” and press **ENTER**.

All contents on the disc are erased.

Hints

- By reformatting, you can change the recording format on DVD-RWs, or record again on DVD-RWs that have been finalized.
- For DVD+RWs and DVD-RWs (Video mode), you can check free space and title location on the disc using the Disc Map display (page 60).

Note

On this model, 1 GB (read “gigabyte”) is equivalent to 1 billion bytes. The larger the number, the larger the disc space.

2. Recording a Programme

+RW **-RWVR** **-RWVideo** **+R** **-R**

This section introduces the basic operation to record the current TV programme to a disc (DVD). For an explanation of how to make timer recordings, see page 36.

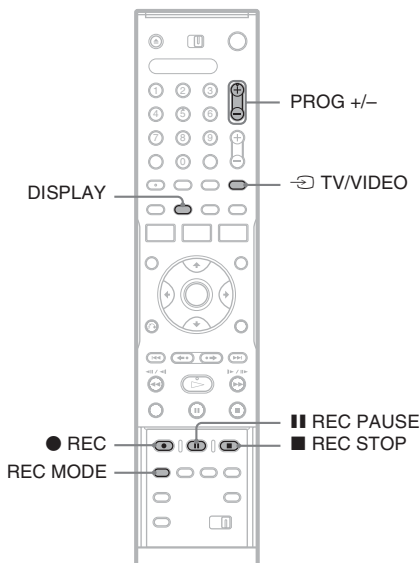

1 Insert a recordable DVD.

See “Inserting a Disc” on page 25.

2 Press PROG +/- to select the programme position or input source you want to record.

3 Press REC MODE repeatedly to select the recording mode.

Each time you press the button, the display on the TV screen changes as follows:



For more details about the recording mode, see page 36.

4 Press ● REC.

Recording starts.

Recording stops automatically after 8 hours of continuous recording or when the DVD is full.

To stop recording

Press ■ REC STOP located beneath the remote control cover.

Note that it may take a few seconds for recorder to stop recording.

To pause recording

Press ▬ REC PAUSE located beneath the remote control cover.

To restart recording, press the button again.

To watch another TV programme while recording

Set your TV to the TV input using the ⇨ TV/VIDEO button (page 18).

💡 Hint

If you do not want to watch TV while recording, you can turn off the TV. When using a decoder, make sure to leave it on.

⚡ Notes

- After pressing ● REC, it may take a short while to start recording.
- You cannot change the recording mode while recording or during recording pause.
- If there is a power failure, the programme you are recording may be erased.

Checking the disc status while recording

You can check the recording information such as recording time or disc type.

Press DISPLAY twice during recording.

The recording information appears.

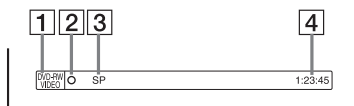

- 1 Disc type/format
- 2 Recording status
- 3 Recording mode
- 4 Recording time

Press DISPLAY to turn off the display.

3. Playing the Recorded Programme (Title List)

+RW -RWVR -RWVideo +R -R

To play a recorded title, select the title from the Title List.

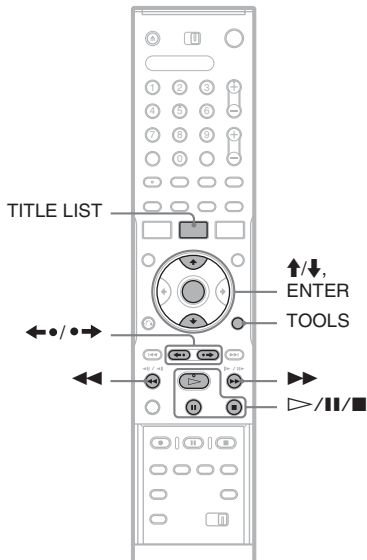

- 1 Insert a DVD.**
See "Inserting a Disc" on page 25.
Playback starts automatically depending on the disc.
- 2 Press TITLE LIST.**
To show the extended Title List, press TOOLS to select "Display List," and press ENTER.

Title List with Thumbnail Images (Example: DVD-RW in VR mode)

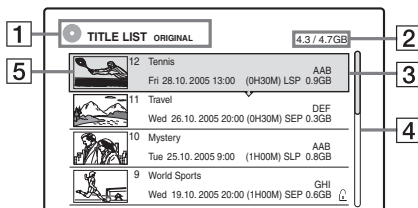

Extended Title List



- 1 Title type:**
Displays the title type (Original or Playlist) for DVD-RWs (VR mode).
- 2 Disc space (remainder/total)**
- 3 Title information:**
Displays the title number, title name, and recording date. Title size is shown in the Thumbnail title list.
● (red): Indicates that the title is currently being recorded.
🔒: Indicates the protected title.
- 4 Scroll bar:**
Appears when all of the titles do not fit on the list. To view the hidden titles, press **↑/↓**.
- 5 Title's thumbnail picture**
The still images for each title are displayed.

3 Select a title, and press ENTER.

The sub-menu appears.

The sub-menu displays options applicable only to selected item. The displayed options differ depending on the model, situation, and disc type.

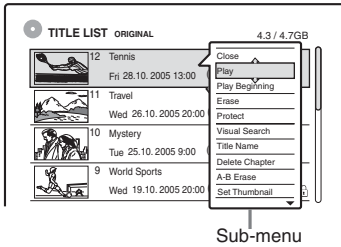

4 Select “Play,” and press ENTER.

Playback starts from the selected title.

To stop playback

Press ■.

To scroll the list display by page (Page mode)

Press ◀•/•▶ while the list display is turned on. Each time you press ◀•/•▶, the entire Title List changes to the previous/next page of titles.

About the Title List for DVD-RWs (VR mode)

You can switch the Title List to show Original or Playlist.

While the Title List menu is turned on, press TOOLS to select either “Original” or “Playlist,” and press ENTER.

For details, see “Edit options for DVD-RWs (VR mode)” on page 57.

To change the title order (Sort)

While the Title List menu is turned on, press TOOLS to select “Sort Titles.” Press ↑/↓ to select the item, and press ENTER.

Order	Sorted
By Date	in order of when the titles were recorded. The title that is recorded most recently is listed at the top.
By Title	in alphabetical order.
By Number	in order of recorded title number.

To change a title thumbnail picture (Thumbnail) (DVD-RW in VR mode only)

You can select a favourite scene for the thumbnail picture shown in the Title List menu.

- 1 Press TITLE LIST in stop mode.
- 2 Select a title whose thumbnail picture you want to change, and press ENTER. The sub-menu appears.
- 3 Select “Set Thumbnail,” and press ENTER. The selected title starts to play in the background.
- 4 While watching the playback picture, press ▷, ■, or ◀◀/▶▶ to select the scene you want to set for a thumbnail picture, and press ENTER. The display asks for confirmation.
- 5 Select “OK,” and press ENTER. The scene is set for the title’s thumbnail picture.

To turn off the Title List

Press TITLE LIST.

💡 Hints

- After recording, the first scene of the recording (the title) is automatically set as the thumbnail picture.
- You can select “TITLE LIST” from the System Menu.

⚡ Notes

- The title names may not appear for DVDs created on other DVD recorders.
- The letters that cannot be displayed are replaced with “*.”
- It may take a few seconds for the thumbnail pictures to be displayed.
- After editing, the title thumbnail picture may change to the first scene of the recording (title).
- After dubbing, the title thumbnail picture set on the source recording is cancelled.

4. Displaying the Playing Time and Play Information



You can check the playing time and remaining time of the current title, chapter, or track. Also, you can check the disc name recorded on the DVD/CD.

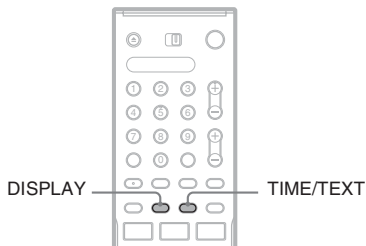

Press DISPLAY repeatedly.

Each time you press the button, the display changes as follows:

Display 1 → Display 2 → Display off

The displays differ depending on the disc type or playing status.

◆ Display 1

Example: When playing a DVD VIDEO

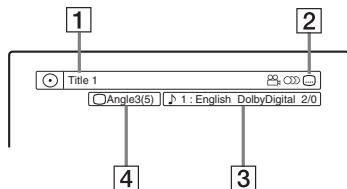

- 1 Title number/name
(Shows either track number, track name, scene number, or file name for CDs, VIDEO CDs, DATA DVDs, or DATA CDs.)
- 2 Available functions for DVD VIDEOS (angle/Ⓞ) audio/Ⓞ subtitle, etc.), or playback data for DATA DVDs and DATA CDs

- 3 The current selected function or audio setting (appears only temporarily)

Example: Dolby Digital 5.1 ch
Rear (L/R)

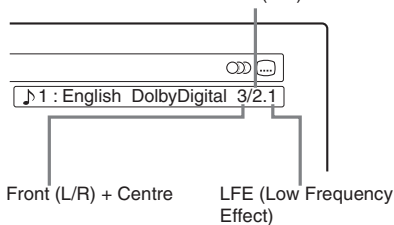

- 4 The current selected angle

◆ Display 2

Example: When playing a DVD-RW (VR mode)

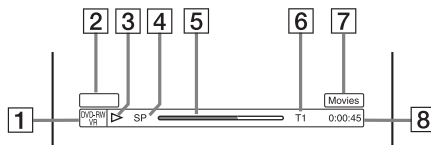

- 1 Disc type^{*1}/format (page 8)
- 2 Title type (only appears for Playlists) (page 57)
- 3 Play mode
- 4 Recording mode (page 36)
- 5 Playing status bar^{*2}
- 6 Title number (chapter number^{*3}) (page 52)
(Shows either track number, scene number, album number^{*3}, or file number for CDs, VIDEO CDs, DATA DVDs, or DATA CDs.)
- 7 Album name appears for CDs with CD text, DATA DVDs or DATA CDs when you press TIME/TEXT repeatedly.
- 8 Playing time (remaining time^{*3})

^{*1} Displays Super VIDEO CDs as "SVCD," DATA CDs as "CD" and DATA DVDs as "DVD."

^{*2} Does not appear with VIDEO CDs, DATA DVDs, and DATA CDs.

^{*3} Displayed when you press TIME/TEXT repeatedly.

Hints

- If “DTS” is set to “Off” in “Audio” setup, the DTS track selection option will not appear on the screen even if the disc contains DTS tracks (page 75).
- When “Auto Display” is set to “On” (default) in “Options” setup (page 78), playback information automatically appears when the recorder is turned on, etc.

Note

The letters or symbols that cannot be displayed are replaced with “*.”

Checking the playing/remaining time

You can view the playing or time information displayed on the TV screen and the front panel display.

Press TIME/TEXT repeatedly.

The displays differ depending on the disc type or playing status.

◆ Front panel display

Example: When playing a DVD

Playing time and number of the current title

T1 1:03:24

Remaining time of the current title

T1 - 1:15:36

Playing time and number of the current chapter

C2 0:22:30

Remaining time of the current chapter

C2 - 0:13:20

Example: When playing a VIDEO CD

Playing time and number of the current scene or track

3 2:15

Example: When playing a CD

Track playing time and the current track/index number

Remaining time of the current track

Playing time of the disc

Remaining time of the disc

CD text (when available)

Example: When playing an MP3 audio track

Playing time and number of the current track

Current album number

Example: When viewing a JPEG image

Current file number and total number of files in the current album

Current album number and total number of albums

Notes

- The recorder can only display the first level of a CD's text, such as the disc name.
- The letters or symbols that cannot be displayed are replaced with “*.”
- Playing time of MP3 audio tracks may not be displayed correctly.

5. Changing the Name of a Recorded Programme

You can label a DVD, title, or programme by entering characters. You can enter up to 64 characters for a title or disc name, but the actual number of characters displayed in the menus such as the Title List will vary. The steps below explain how to change the name of the recorded programme.

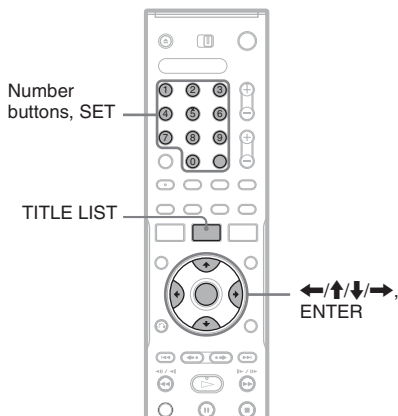

- 1** Press **TITLE LIST**.
The sub-menu appears.
- 2** Select a title, and press **ENTER**.
The display for entering characters appears.
- 3** Select **"Title Name,"** and press **ENTER**.
The display for entering characters appears.
- 4** Press **←/↑/↓/→** to move the cursor to the right of the screen and select **"A"** (upper-case), **"a"** (lower-case), or **"Symbol,"** and press **ENTER**.
The characters of the selected type are displayed.

- 5** Press **←/↑/↓/→** to select the character you want to enter, and press **ENTER**.

The selected character appears at the top of the display.

Example: Input Title Name

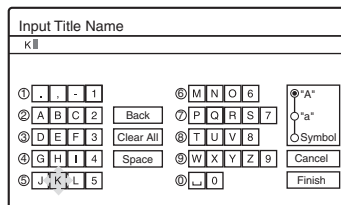

The type of characters will change according to the language you select in "Easy Setup." Some languages allow you to enter an accent mark.

To enter a letter with an accent mark, select an accent followed by the letter.

Example: Select " ` " and then " a " to enter " à ."

To insert a space, select "Space."

- 6** Repeat steps 4 and 5 to enter the remaining characters.

Input row

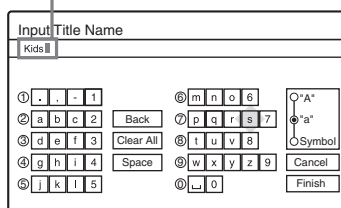

To erase a character, move the cursor to the right of the character at the input row. Select "Back" and press **ENTER**.

To insert a character, move the cursor to the right of the point where you want to insert the character. Select the character and press **ENTER**.

To erase all of the characters, select "Clear All" and press **ENTER**.

- 7** Select **"Finish,"** and press **ENTER**.
To cancel the setting, select "Cancel."

Protecting a disc

-RWVR

- 1 Insert a disc.
See “Inserting a Disc” on page 25.
- 2 Press **TOOLS** to select “Disc Info,” and press **ENTER**.

Disc Information			
DiscName			
Media	DVD-RW	Format	VR
Title no.	Original 3 / Playlist 2		
Date	13.10.2005 - 28.10.2005		Off
Remainder	HQ: 0H30M LSP: 1H15M SLP: 3H00M	HSP: 0H45M LP: 1H30M SEP: 4H00M	SP: 1H00M EP: 2H00M
			2.3/4.7GB

Buttons: Close, Disc Name, Protect Disc, Finalize, Erase All, Format

- 3 Select “Protect Disc,” and press **ENTER**.
- 4 Select “Protect,” and press **ENTER**.

To cancel the protection

Select “Don’t Protect” in step 4.

Hint

You can set protection for individual titles (page 58).

7. Playing the Disc on Other DVD Equipment (Finalize)

+RW -RWVR -RWVideo +R -R

Finalizing is necessary when you play discs recorded with this recorder on other DVD equipment.

When you finalize a DVD+RW, DVD-RW (Video mode), DVD+R, or DVD-R, a DVD menu will be automatically created, which can be displayed on other DVD equipment.

Before finalizing, check the differences between the disc types in the table below.

Differences between the disc types

+RW Discs are automatically finalized when removed from the recorder. However, you may need to finalize the disc for certain DVD equipment, or if the recording time is short. You can edit or record on the disc even after finalizing.

-RWVR Finalizing is unnecessary when playing a disc on VR format compatible equipment. Even if your other DVD equipment is VR format compatible, you may need to finalize the disc, especially if the recording time is short. You can edit or record on the disc even after finalizing.

-RWVideo Finalizing is necessary when playing on any equipment other than this recorder. After finalizing, you cannot edit or record on the disc. If you want to record on it again, unfinalize or reformat the disc (page 25). However, if you reformat the disc, all recorded contents will be erased.

+R Finalizing is necessary when playing on any equipment other than this recorder.
-R After finalizing, you cannot edit or record on the disc.

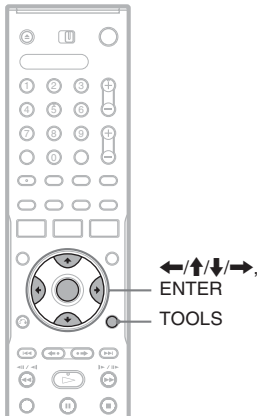

- 1 Insert a disc.**
See “Inserting a Disc” on page 25.
- 2 Press TOOLS to select “Disc Info,” and press ENTER.**
The “Disc Information” display appears.
- 3 Select “Finalize,” and press ENTER.**
The display shows the approximate time required for finalizing and asks for confirmation.

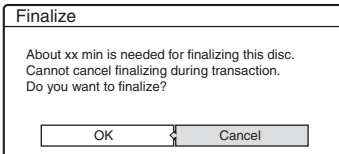

- 4 Select “OK,” and press ENTER.**
The recorder starts finalizing the disc.

Hint

You can check whether the disc has been finalized or not. If you cannot select “Finalize” in step 3 above, the disc has already been finalized.

Notes

- Depending on the condition of the disc, recording, or the DVD equipment, discs may not play even if the discs are finalized.
- The recorder may not be able to finalize the disc if it was recorded on another recorder.

Unfinalizing a disc

-RWVR **+RW_{Video}**

For DVD-RWs (Video mode)

DVD-RW (Video mode) that have been finalized to prohibit additional recording or editing can be unfinalized to allow further recording or editing.

For DVD-RWs (VR mode)

If you cannot record or edit on a DVD-RW (VR mode) that has been finalized with other DVD equipment, “This disc was finalized. Unfinalize it.” may appear.

Note

The recorder is not able to unfinalize DVD-RWs (Video mode) that have been finalized on another recorder.

- 1 Insert a disc.**
See “Inserting a Disc” on page 25.
- 2 Press TOOLS to select “Disc Info,” and press ENTER.**
The “Disc Information” display appears.
- 3 Select “Unfinalize,” and press ENTER.**
The recorder starts unfinalizing the disc. Unfinalizing may take several minutes.

Before Recording

Before you start recording...

- This recorder can record on various discs. Select the disc type according to your needs (page 8).
- Check that the disc has enough available space for the recording (page 25). For DVD+RWs and DVD-RWs, you can free up disc space by erasing titles (page 60).
- Adjust the recording picture quality and picture size if necessary (page 40).

Hint

Timer recordings will be made regardless whether or not the recorder is turned on. You can turn off the recorder without affecting the recording even after recording starts.

Note

To play a recorded disc on other DVD equipment, finalize the disc (page 34).

Recording mode

Like the SP or LP recording mode of VCRs, this recorder has eight different recording modes. Select a recording mode according to the time and picture quality you need. For example, if picture quality is your top priority, select the High Quality mode (HQ). If recording time is your priority, Super Extended Play mode (SEP) can be a possible choice. Note that recording times in the following table are approximate and the actual times may differ. Note also that the maximum continuous recording time for a single title is eight hours. Contents beyond this time will not be recorded.

Press REC MODE repeatedly to switch the recording modes.

Recording mode	Recording time (hours)	
	DVD	DVD+R DL
HQ (High quality)	1	1 hr. 48 min.
HSP ↑	1 hr. 30 min.	2 hr. 42 min.
SP (Standard mode)	2	3 hr. 37 min.
LSP ↓	2 hr. 30 min.	4 hr. 31 min.
LP ↓	3	5 hr. 25 min.
EP ↓	4	7 hr. 14 min.
SLP ↓	6	10 hr. 51 min.
SEP (Long duration)	8	14 hr. 28 min.

Note

Situations below may cause slight inaccuracies with the recording time.

- Recording a programme with poor reception, or a programme or video source of low picture quality
- Recording on a disc that has already been edited
- Recording only a still picture or just sound

Recording stereo and bilingual programmes

The recorder automatically receives and records stereo and bilingual programmes based on the ZWEITON system or the NICAM system.

A DVD-RW (VR mode) can record both main and sub sounds. You can switch between main and sub when playing the disc.

A DVD+RW, DVD-RW (Video mode), DVD+R, or DVD-R can record only one sound track (main or sub) at a time. Select the sound track using the Setup Display before recording starts. Set “DVD Bilingual Rec.” to “Main” (default) or “Sub” in “Options” setup (page 78).

ZWEITON (German stereo) system

When a stereo based programme is received, “Stereo” appears.

When a bilingual ZWEITON based programme is received, “Main,” “Sub,” or “Main/Sub” appears.

NICAM system

When a stereo or bilingual NICAM based programme is received, “NICAM” appears in the front panel display.

To record a NICAM programme, be sure to set “Audio” of “Channel Setting” in “Settings” setup to “NICAM” (default). If the sound is not clear when listening to NICAM broadcasts, set “Audio” to “Standard” (see “Channel Setting” on page 68).







Hint

You can select the audio (main or sub) while recording bilingual programmes using the  (audio) button. This does not affect the recorded sound.

Unrecordable pictures

Pictures with copy protection cannot be recorded on this recorder.

When the recorder receives a copy guard signal, the recorder continues to record but only a blank, grey coloured screen will be recorded.

Copy control signals	Recordable discs
Copy-Free	    
Copy-Once	 (CPRM*)
Copy-Never	None (a blank screen is recorded)

* The recorded disc can be played only on CPRM compatible equipment (page 8).

Timer Recording (Standard/ShowView)



You can set the timer for a total of 30 programmes, up to one month in advance.

There are two methods to set the timer: the standard method and ShowView method.

- Standard: Set the date, time, and programme position of the programme manually.
- ShowView: Enter the ShowView number designated for each TV programme (page 39).

Note that this function may not be available in some areas.

Setting the timer manually (Standard)

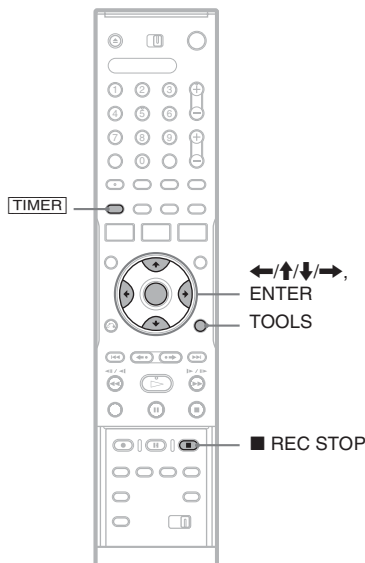

1 Press **TIMER**.

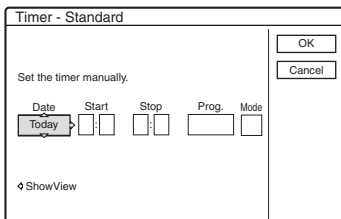

- If the “Timer – ShowView” display appears, press **←** to switch the display to “Standard”.

2 Select an item using **←/→** and adjust using **↑/↓**.

“Date”: Sets the date.

The item changes as follows:

Today **↔** Tomorrow **↔** **↔** Thu
28.10 (1 month later) **↔** Sun (every Sunday)
↔ **↔** Sat (every Saturday) **↔**
Mon-Fri (Monday to Friday) **↔** Mon-Sat
(Monday to Saturday) **↔** Sun-Sat (Sunday to
Saturday) **↔** Today

“Start”: Sets the start time.

“Stop”: Sets the stop time.

“Prog.”: Selects the programme or input source.

“Mode”: Selects the recording mode (page 36).

- If you make a mistake, select the item and change the setting.

3 Select “OK,” and press **ENTER**.

The Timer List (page 42) appears. The **TIMER REC** indicator lights up on the front panel and the recorder is ready to start recording.

Unlike a VCR, there is no need to turn off the recorder before the timer recording starts.

To stop recording during timer recording

Open the remote’s cover and press **■ REC STOP**. Note that it may take a few seconds for the recorder to stop recording.

Rec Mode Adjust

If there is not enough available disc space for the recording, the recorder automatically adjusts the recording mode to enable the entire programme to be recorded. This function is normally set to “On.”

To cancel this function, press **TOOLS** while the Timer List is displayed. Select “Rec Mode Adjust” and press **ENTER**. Select “Off” and press **ENTER**.

If the timer settings overlap

Overlapped timer settings are shown as follows.

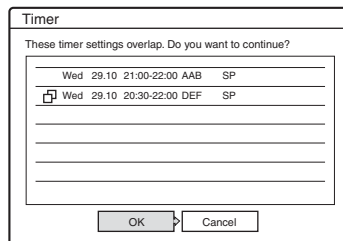

To store the setting as shown, select “OK.” The programme that starts first has priority and the second programme starts recording only after the first programme has finished. To cancel the overlapped setting, select “Cancel.”

To confirm, change, or cancel timer recording

See “Checking/Changing/Canceling Timer Settings (Timer List)” on page 42.

To extend the recording duration time while recording

- 1 Press **TOOLS** during recording to select “Extend Rec.,” and press **ENTER**.

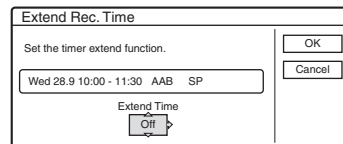

- 2 Press **↑/↓** to select the duration time. You can set the duration in increments of 10 minutes, for a maximum of 60 minutes.
- 3 Select “OK” and press **ENTER**.

Hint

You can play the recorded programme by selecting the programme title in the Title List.

Notes

- If a message indicating that the disc is full appears on the screen, change the disc, or make available space for the recording (DVD+RW/DVD-RW only) (page 60).
- Check that the clock is correctly set before setting the timer recording. If not, the timer recording cannot be made.
To record a satellite programme, turn on the satellite tuner and select the satellite programme you want to record. Leave the satellite tuner turned on until the recorder finishes recording. If you connect equipment with a timer function, you can use the Synchro Rec function (page 43).
- Even if the timer is set for the same daily or weekly programme, the timer recording cannot be made if it overlaps with a programme that has priority. “□” will appear next to the overlapped setting in the Timer List. Check the priority order of the settings.
- Even if the timer is set, timer recordings cannot be made while recording a programme that has priority.
- The Rec Mode Adjust function only works with a timer recording. It does not function with Quick Timer or Synchro Rec.

Recording TV programmes using the ShowView system

The ShowView system is a feature that simplifies setting the timer. Just enter the ShowView number listed in the TV programme guide. The date, time, and programme position of that programme are set automatically. Note that this function may not be available in some areas.

Check that the programme positions are correctly set in “Channel Setting” in “Settings” setup (page 68).

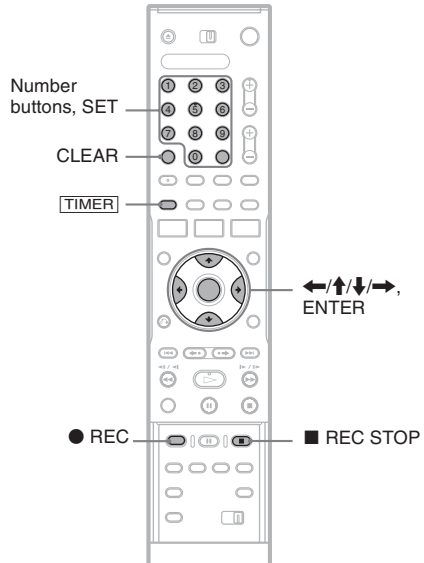

1 Press **TIMER**.

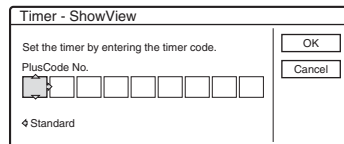

- If the “Timer – Standard” display appears, press **←** to switch the display to “ShowView.”

2 Press the number buttons to enter the ShowView number, and press SET.

- If you make a mistake, press CLEAR and re-enter the correct number.

3 Select “OK,” and press ENTER.

The date, start and stop times, programme position, recording mode, etc. setting appear.

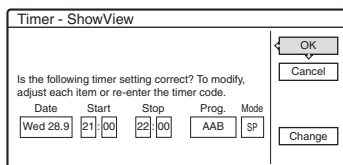

- If you want to change the setting, press ←/→ to select the item and press ↑/↓ to change the setting.

To re-enter the ShowView number, select “Change.”

4 Select “OK,” and press ENTER.

The TIMER REC indicator lights up on the front panel, and the recorder is ready to start recording.

To stop recording during timer recording

Open the remote’s cover and press ■ REC STOP. Note that it may take a few seconds for the recorder to stop recording.

If the timer settings overlap

See page 38.

To extend the recording duration time while recording

See page 38.

To confirm, change, or cancel timer recording

See “Checking/Changing/Cancelling Timer Settings (Timer List)” on page 42.

Hint

The Rec Mode Adjust function also works with this timer method (page 38).

Using the Quick Timer function

You can set the recorder to record in 30-minute increments.

Press ● REC repeatedly to set the duration.

Each press advances the time in 30-minute increments. The maximum duration is six hours.

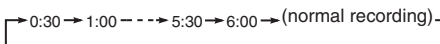

The time counter decreases minute by minute to 0:00, then the recorder stops recording (power does not turn off). Even if you turn off the recorder during recording, the recorder continues to record until the time counter runs out.

To cancel the Quick Timer

Press ● REC repeatedly until the counter appears in the front panel display. The recorder returns to normal recording mode.

Adjusting the recording picture quality and size

You can adjust the recording picture quality and picture size.

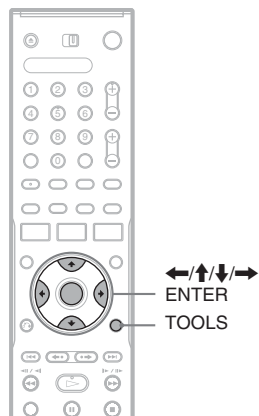

1 Before recording starts, press **TOOLS** to select “Rec Settings,” and press **ENTER**.

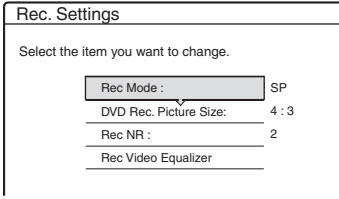

2 Select the item you want to adjust, and press **ENTER**.

The adjustment display appears.

Example: Rec NR



“Rec Mode”: Selects the recording mode for the desired recording time and picture quality. For more information, see “Recording mode” on page 36.

“DVD Rec. Picture Size”: Sets the picture size of the programme to be recorded.

- 4:3 (default): Sets the picture size to 4:3.
- 16:9: Sets the picture size to 16:9 (wide mode).

“DVD Rec. Picture Size” works with DVD-Rs and DVD-RWs (Video mode) when the recording mode is set to HQ, HSP, SP, or LSP. For all other recording modes, the screen size is fixed at “4:3.”

For DVD-RWs (VR mode), the actual picture size is recorded regardless of the setting. For example, if a 16:9 size picture is received, the disc records the picture as 16:9 even if “DVD Rec. Picture Size” is set to “4:3.”

For DVD+RWs/DVD+Rs, the screen size is fixed at “4:3.”

“Rec NR” (noise reduction): Reduces noise contained in the video signal.

“Rec Video Equalizer”: Adjusts the picture in greater detail.

Press **↑/↓** to select the item you want to adjust, then press **ENTER**.

- Contrast: Changes the contrast.
- Brightness: Changes the overall brightness.
- Colour: Makes the colours deeper or lighter.

3 Adjust the setting using **←/↑/↓/→**, and press **ENTER**.

The default setting is underlined.

“Rec NR”: (weak) Off 1 ~ 2 ~ 3 (strong)

“Rec Video Equalizer”:

- Contrast: (weak) -3 ~ 0 ~ 3 (strong)
- Brightness: (dark) -3 ~ 0 ~ 3 (bright)
- Colour: (light) -3 ~ 0 ~ 3 (deep)

Repeat steps 2 and 3 to adjust any other items.

Notes

- If one programme contains two picture sizes, the selected size is recorded. However, if the 16:9 signal cannot be recorded as 16:9, it is recorded as 4:3.
- Remnants of images may appear on your screen when using “Rec NR.”
- “Rec Video Equalizer” does not affect the input of the DV IN jack.

Creating chapters in a title

The recorder can automatically divide a recording (a title) into chapters by inserting chapter marks during recording. To disable this function, set “Auto Chapter” in “Features” setup to “Off” (page 76).

When recording on a DVD-RW (VR mode)

The recorder detects changes in the picture and sound and automatically inserts chapter marks. You can also insert and erase chapter marks manually (page 61).

When recording on other recordable discs

Chapter marks are inserted at approximately 6-minute intervals during recording.

Checking/Changing/ Cancelling Timer Settings (Timer List)

+RW -RWVR -RWvideo +R -R

You can check, change, or cancel timer settings using the Timer List.

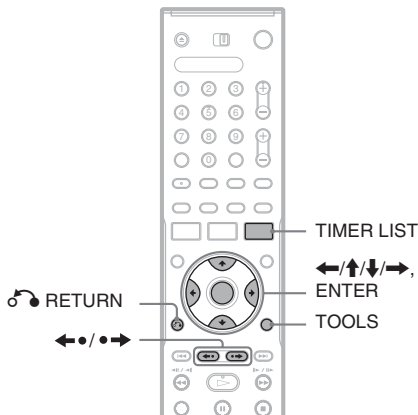

1 Press **TIMER LIST**.

The Timer List appears.

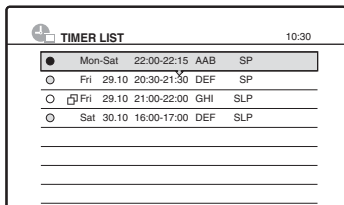

Timer information displays the recording date, time, recording mode, etc.

☐: Indicates that the setting is overlapped by another setting.

● (green): Indicates the setting can be recorded.

● (red): Indicates the setting currently being recorded.

○ (grey): Indicates that the setting cannot be recorded in the selected recording mode.

When all of the timer settings do not fit on the list, scroll bar appears.

To view the hidden timer settings, press **↑/↓**.

2 Select the timer setting you want to check/change/cancel, and press **ENTER**.

The sub-menu appears.

3 Select one of the options, and press **ENTER**.

“Modify”: Changes the timer setting.

Select an item using **←/→** and adjust using **↑/↓**.

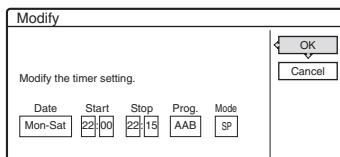

“Erase”: Erases the timer setting. Select “OK,” and press **ENTER**.

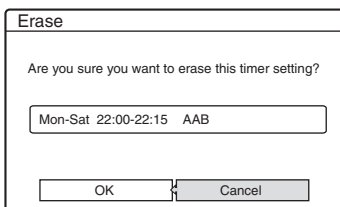

“Check Overlap”: Checks for overlapped settings.

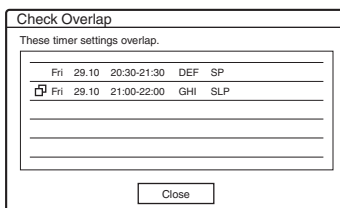

Select “Close” to return to the Timer List.

To change or cancel the setting, repeat steps 2 and 3 above.

When the timer settings overlap

The programme that starts first has priority and the second programme starts recording only after the first programme has finished.

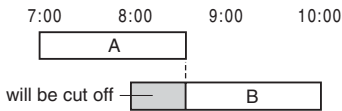

◆ When the recordings start at the same time

The programme that is set last has priority. In this example, timer setting B is set after A, so the first part of timer setting A will not be recorded.

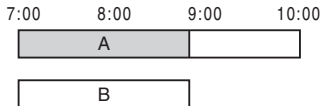

◆ When the end time of one recording and the start time of another are the same

After finishing the previous recording, the other recording may be delayed.

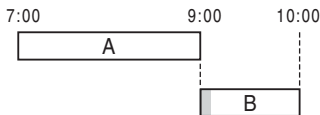

To scroll the list display by page (Page mode)

Press **◀•/•▶** while the list display is turned on. Each time you press **◀•/•▶**, the entire Timer List changes to the previous/next page of timer settings.

To turn off the Timer List

Press **TIMER LIST** or **RETURN**.

💡 Hint

While recording, you cannot modify the timer setting for the current recording, but you can extend the recording duration of the recording time (page 38).

⚡ Notes

- Even if the timer is set, timer recordings cannot be made while recording a programme that has priority.
- Even if the timer is set for the same daily or weekly programme, the timer recording cannot be made if it overlaps with a programme that has priority. “ ” will appear next to the overlapped setting in the Timer List. Check the priority order of the settings.

Recording From Connected Equipment

+RW **-RWVR** **-RWVideo** **+R** **-R**

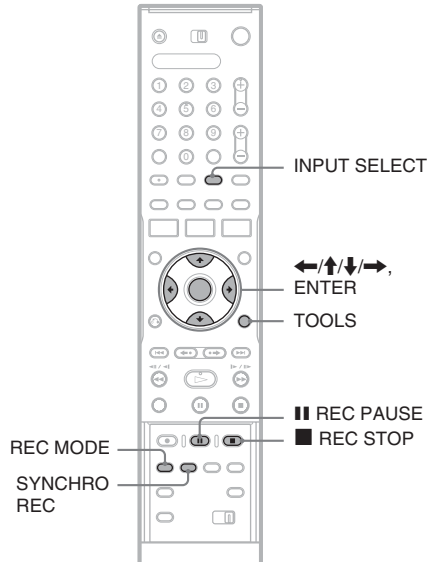

Recording from connected equipment with a timer (Synchro Rec)

You can set the recorder to automatically record programmes from connected equipment that has a timer function (such as a satellite tuner). Connect the equipment to the **LINE IN 1** jacks of the recorder (page 24).

When the connected equipment turns on, the recorder starts recording a programme from the **LINE IN 1** jacks.

1 Insert a recordable DVD.

See “Inserting a Disc” on page 25.

2 Press **INPUT SELECT** repeatedly to select “L1.”

3 Select the line input audio when recording a bilingual programme on the DVD-RWs (VR mode).

Press TOOLS to select “Line Audio Input,” and press ENTER. Then select “Bilingual,” and press ENTER.

For details about bilingual recording, see page 36.

4 Press REC MODE repeatedly to select the recording mode.

For details about the recording mode, see page 36.

5 Set the timer on the connected equipment to the time of the programme you want to record, and turn it off.

6 Press SYNCHRO REC.

The SYNCHRO REC indicator lights up on the front panel. The recorder is ready to start Synchro-Recording.

The recorder automatically starts recording when it receives an input signal from the connected equipment. The recorder stops recording when the connected equipment turns off.

To stop recording

Press ■ REC STOP or SYNCHRO REC.

To cancel Synchro Rec

Press SYNCHRO REC.

The SYNCHRO REC indicator on the recorder turns off.

Notes

- The recorder starts recording only after detecting the video signal from the connected equipment. The beginning of the programme may not be recorded regardless of whether or not the recorder’s power is on or off.
- During Synchro-Recording, other operations such as normal recording cannot be done.
- To use the connected equipment while the recorder is standing by for Synchro-Recording, cancel Synchro-Recording by pressing SYNCHRO REC. Be sure to turn off the connected equipment and press SYNCHRO REC to reset Synchro-Recording before the timer recording starts.
- The Synchro Rec function does not work with some tuners. For details, see the tuner’s operating instructions.
- To use the Synchro Rec function, you must first set the recorder’s clock correctly.

If the timer settings of a Synchro-Recording and another timer recording overlap

Regardless of whether or not the programme is a Synchro Rec programme, the programme that starts first has priority and the second programme starts recording only after the first programme has finished.

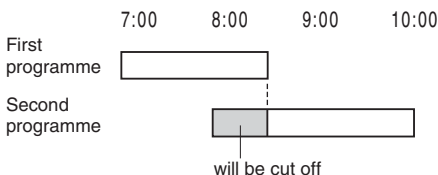

Recording from connected equipment without a timer

You can record from a connected VCR or similar device. To connect a VCR or similar device, see “Connecting a VCR or Similar Device” on page 22. Use the DV IN jack on the front panel if the equipment has a DV output jack (i.LINK jack).

1 Insert a recordable DVD.
See “Inserting a Disc” on page 25.

2 Press INPUT SELECT to select an input source according to the connection you made.
The front panel display changes as follows:

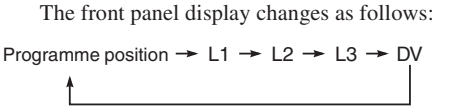

3 Select the line input audio when recording a bilingual programme on the DVD-RWs (VR mode).
Press TOOLS to select “Line Audio Input,” and press ENTER. Then select “Bilingual,” and press ENTER.
For details about bilingual recording, see page 36.

4 Press REC MODE repeatedly to select the recording mode.
For details about the recording mode, see page 36.

5 Press ■ REC PAUSE to set this recorder to record pause.

6 Insert the source tape into the connected equipment and set to playback pause.

7 At the same time, press ■ REC PAUSE on this recorder and the pause or play button on the connected equipment.
Recording starts.
To stop recording, press ■ REC STOP on this recorder.

If you connect a digital video camera with a DV IN jack

See “DV Dubbing” on page 64 for an explanation of how to record from the DV IN jack.

💡 Hint
You can adjust the settings for the recording picture before recording. See “Adjusting the recording picture quality and size” on page 40.

⚡ Notes

- When recording a video game image, the screen may not be clear.
- Any programme that contains a Copy-Never copy guard signal cannot be recorded. The recorder continues to record, but a blank screen will be recorded.

Playback

Playing

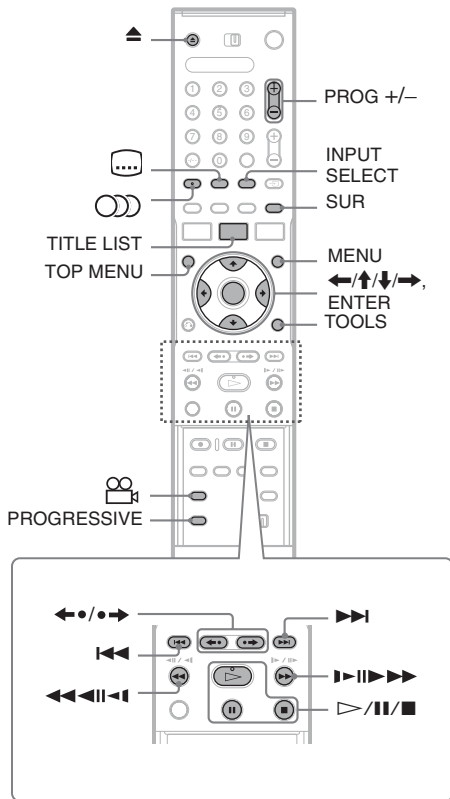

1 Insert a disc.

- See “Inserting a Disc” on page 25.
- If you insert a DVD VIDEO, VIDEO CD, or CD, press \triangleright . Playback starts.

2 Press TITLE LIST.

For details about the Title List, see “3. Playing the Recorded Programme (Title List)” on page 28.

Example: DVD-RW (VR mode)

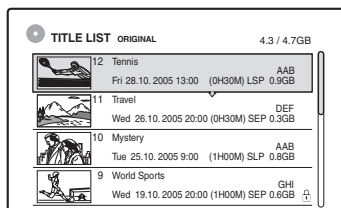

3 Select the title, and press ENTER.

The sub-menu appears.

4 Select “Play,” and press ENTER.

Playback starts from the selected title.

To use the DVD’s Menu

When you play a DVD VIDEO, or a finalized DVD+RW, DVD-RW (Video mode), DVD+R, or DVD-R, you can display the disc’s menu by pressing TOP MENU or MENU.

To play VIDEO CDs with PBC functions

PBC (Playback Control) allows you to play VIDEO CDs interactively using the menu on your TV screen.

When you start playing a VIDEO CD with PBC functions, the menu appears.

Select an item using the number buttons and press ENTER. Then, follow the instructions in the menu (press \triangleright when “Press SELECT” appears).

The PBC function of Super VIDEO CDs does not work with this recorder. Super VIDEO CDs are played in continuous play mode only.

To stop playback

Press \blacksquare .

To resume playback from the point where you stopped (Resume Play)

When you press \triangleright again after you stop playback, the recorder resumes playback from the point where you pressed \blacksquare .

To start from the beginning, press TOOLS to select “Play Beginning,” and press ENTER. Playback starts from the beginning of the title/track/scene.

The point where you stopped playing is cleared when:

- you open the disc tray.
- you play another title.
- you switch the Title List menu to Original or Playlist (DVD-RW in VR mode only).
- you edit the title after stopping playback.
- you change the settings on the recorder.
- you turn off the recorder (VIDEO CD/CD/DATA DVD/DATA CD only).
- you make a recording (except for DVD-RWs in VR mode).
- you switch between JPEG and MP3.

To play restricted DVDs (Parental Control)

If you play a restricted DVD, the message “Do you want temporarily change parental control to *?” appears on your TV screen.

- 1** Select “OK” and press ENTER.
The display for entering your password appears.
- 2** Enter your four-digit password using the number buttons.
- 3** Press ENTER to select “OK.”
The recorder starts playback.

To register or change the password, see “Parental Control (DVD VIDEO only)” on page 76.

To lock the disc tray (Child Lock)

You can lock the disc tray to prevent children from ejecting the disc.

When the recorder is turned on, hold down \blacksquare until “LOCKED” appears in the front panel display.

The \blacktriangle (open/close) button does not work while the Child Lock is set.

To unlock the disc tray, hold down \blacksquare until “UNLOCKED” appears in the front panel display when the recorder is turned on.





Hints

- You can also use the \triangleright button in step 3 (page 46) to start playback.
- Even if you select “Factory Setup” in “Options” setup (page 78), the Child Lock remains set.

Playback options

To check the position of the buttons below, see the illustration on page 46.

Buttons	Operations								
(audio) 	Selects one of the audio tracks recorded on the disc when pressed repeatedly. : Selects the language. : Selects the main or sub sound. : Selects stereo or monaural audio tracks.								
(subtitle) 	Selects a subtitle language when pressed repeatedly.								
(angle) 	Selects an angle when pressed repeatedly. If various angles (multi-angles) for a scene are recorded on the disc, “” appears in the front panel display.								
SUR (surround) 	Selects one of the TVS effects when pressed repeatedly. TVS* (TV Virtual Surround) lets you enjoy virtual surround sound effects created from the front left and right speakers. The selected setting is displayed in the front panel display for a few seconds. “TVS OFF”: No surround effect “TVS DYNAMIC”: Creates one set of virtual rear speakers. “TVS WIDE”: Creates five sets of virtual rear speakers. “TVS NIGHT”: Creates five sets of virtual rear speakers. Effective at low volume. “TVS STANDARD”: Creates three sets of virtual rear speakers. Effective when you use two separate front speakers. * TVS was developed by Sony to produce home surround sound with just a stereo TV.								
PROGRESSIVE 	Switches the type of video output signal to interlace or progressive format (page 15).								
(instant replay/ instant advance) 	Replays the scene/briefly fast forwards the scene.								
(previous/ next)	Goes to the beginning of the previous/next title/chapter/scene/track.								
(fast reverse/fast forward)	Fast reverses/fast forwards the disc when pressed during playback. Search speed changes as follows: <div style="text-align: center; margin: 10px 0;"> <table style="margin: auto;"> <tr> <td style="padding: 0 10px;">fast reverse</td> <td style="padding: 0 10px;">fast forward</td> </tr> <tr> <td style="text-align: center;">◀◀1 ←</td> <td style="text-align: center;">→ 1▶▶</td> </tr> <tr> <td style="text-align: center;">◀◀2 ← ←</td> <td style="text-align: center;">→ → 2▶▶</td> </tr> <tr> <td style="text-align: center;">◀◀3* ← ← ←</td> <td style="text-align: center;">→ → → 3▶▶*</td> </tr> </table> </div> When you press and hold the button, fast forward/fast reverse continues at the selected speed until you release the button. * ◀◀3 and 3▶▶ are only available for DVDs.	fast reverse	fast forward	◀◀1 ←	→ 1▶▶	◀◀2 ← ←	→ → 2▶▶	◀◀3* ← ← ←	→ → → 3▶▶*
fast reverse	fast forward								
◀◀1 ←	→ 1▶▶								
◀◀2 ← ←	→ → 2▶▶								
◀◀3* ← ← ←	→ → → 3▶▶*								

Buttons	Operations
 (slow, freeze frame)	Plays in slow motion when pressed for more than one second in pause mode. Plays one frame at a time when pressed briefly in pause mode.
	
	
 *	
* Playback direction only	
 (pause)	Pauses playback.

To resume normal playback, press .

Notes

- To enjoy the TVS function, set “Digital Out” to “On” and “Dolby Digital” to “D-PCM” and “MPEG” to “PCM” in “Audio” setup.
- The volume may be reduced when surround effects are set.
- When the playback signal does not contain a signal for the rear speakers, the surround effects will be difficult to hear.
In addition, the surround effects may also be difficult to hear depending on the title being played and the environment where the recorder is being used.
- When you select one of the surround modes, turn off the surround settings of the connected TV or amplifier (receiver).
- Make sure that your listening position is between and at an equal distance from your speakers, and that the speakers are located in similar surroundings.
- Angles and subtitles cannot be changed with titles recorded on this recorder.
- When you use the DIGITAL OUT (COAXIAL or OPTICAL) jack to listen to MPEG audio signals and set “MPEG” to “MPEG” in “Audio” setup, no sound will come from your speakers if you select one of the TVS modes.
- 96 kHz PCM audio and DTS audio do not have surround effects.

Notes on playing DTS sound tracks on a CD

- When playing DTS-encoded CDs, excessive noise will be heard from the analogue stereo jacks. To avoid possible damage to the audio system, the consumer should take proper precautions when the analogue stereo jacks of the recorder are connected to an amplification system. To enjoy DTS Digital Surround™ playback, an external 5.1-channel decoder system must be connected to the digital jack of the recorder.
- Set the sound to “Stereo” using the  (audio) button when you play DTS sound tracks on a CD (page 48).

Notes on playing DVDs with a DTS sound track

DTS audio signals are output only through the DIGITAL OUT (COAXIAL or OPTICAL) jack.
When you play a DVD with DTS sound tracks, set “DTS” to “On” in “Audio” setup (page 75).

Adjusting the picture quality

+RW -RWvR -RWvideo +R -R DVD

VCD

- 1 Press **TOOLS** during playback to select “Video Settings,” and press **ENTER**.

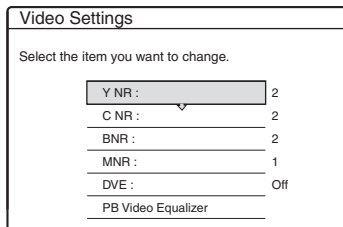

- 2 Select an item, and press **ENTER**.

The adjustment display appears.

“Y NR” (luminance noise reduction):

Reduces noise contained in the luminance element of the video signal.

“C NR” (chroma noise reduction): Reduces noise contained in the colour element of the video signal.

“BNR” (block noise reduction): Reduces “block noise” or mosaic like patterns in the picture.

“MNR” (mosquito noise reduction): Reduces the faint noise appearing around the outlines of the images. The noise reduction effects are automatically adjusted within each setting range according to the video bit rate and other factors.

“DVE” (digital video enhancer): Sharpens the outlines of the images.

“PB Video Equalizer” (Playback video equalizer): Adjusts the picture in greater detail.

Select an item and press **ENTER**.

- Contrast: changes the contrast.
- Brightness: changes the overall brightness.
- Colour: makes the colours deeper or lighter.
- Hue: changes the colour balance.

- 3 Press **←/→** to adjust the setting, and press **ENTER**.

The default settings are underlined.

“Y NR”: (weak) Off 1 2 3 (strong)

“C NR”: (weak) Off 1 2 3 (strong)

“BNR”: (weak) Off 1 2 3 (strong)

“MNR”: (weak) Off 1 2 3 (strong)

“DVE”*: (weak) Off 1 2 3 (strong)

“PB Video Equalizer”:

• Contrast: (weak) -3 ~ 0 ~ 3 (strong)

• Brightness: (dark) -3 ~ 0 ~ 3 (bright)

• Colour: (light) -3 ~ 0 ~ 3 (deep)

• Hue: (red) -3 ~ 0 ~ 3 (green)

Repeat steps 2 and 3 to adjust any other items.

* “1” softens the outlines of the images. “2” enhances the outlines and “3” enhances them more than “2.”

Notes

- If the outlines of the images on your screen become blurred, set “BNR” and/or “MNR” to “Off.”
- Depending on the disc or the scene being played, the above BNR, MNR, Y NR, or C NR effects may be hard to discern. And, these functions may not work with some screen sizes.
- When using the DVE function, noise found in the title may become more apparent. In this case, it is recommended that you use the BNR function with the DVE function. If the condition still does not improve, set the DVE level to “1” or “Off.”

Adjusting the sound quality

+RW -RWvR -RWvideo +R -R DVD

VCD CD DATA CD

- 1 Press **TOOLS** during playback to select “Audio Settings,” and press **ENTER**.

- 2 Select an item, and press **ENTER**.

“Surround” (TVS): Selects one of the surround modes. For more information, see “Playback options” on page 48.

“Audio Filter”: Selects the digital filter to reduce noise above 22.05 kHz (Fs* is 44.1 kHz), 24 kHz (Fs is 48 kHz), or 48 kHz (Fs is above 96 kHz).

- Sharp (default): Provides a wide frequency range and spatial feeling.
 - Slow: Provides smooth and warm sound.
- “AV SYNC”: When the video is delayed, this function delays the audio for synchronization with the video (0 to 120 milliseconds). Larger numbers indicate a longer audio delay for synchronization with the video. When dubbing to a VCR or other video recording equipment, be sure to return this setting to 0 ms (default).

* Sampling frequency of audio source. This function only adjusts the output signals from the LINE OUT (R-AUDIO-L).

3 Press ←/↑/↓/→ to select the option, and press ENTER.

Note

There may be little effect by changing the Audio Filter depending on the disc or playback environment.

Playing from the beginning of the programme you are recording (Chasing Playback)

-RWVR

“Chasing Playback” allows you to view the recorded part of a programme while the recording is being made. You do not need to wait until the recording finishes.

Press TOOLS while recording to select “Chasing Playback,” and press ENTER.

Playback starts from the beginning of the programme you are recording.

When you fast forward to the point that you are recording, Chasing Playback returns to normal playback.

Notes

- For DVD-RWs (VR mode), this function does not work when recording:
 - on a 1x-speed DVD-RW.
 - in the HQ or HSP recording mode.
- The DVD’s picture on your TV screen freezes for a few seconds when you fast forward/fast reverse or instant replay/advance the recording.
- Chasing Playback is possible from one minute or more after recording starts.
- Even if you fast forward the recorded programme, there will always be a time difference of about one minute or more between the recorded programme and the current TV broadcast.

Playing a previous recording while making another (Simultaneous Rec and Play)

-RWVR

You can play a previously recorded program while recording another on the same disc. Playback continues even if the recording is a timer recording.

1 While recording, press TITLE LIST.

The Title List appears.

2 Select the title you want to play, and press ENTER.

The sub-menu appears.

3 Select “Play”, and press ENTER.

Playback starts from the selected title.

Notes

- This function does not work when recording:
 - on a 1x-speed DVD-RW (digital video disc-rewritable, minus RW).
 - in the HQ or HSP recording mode.
- When playing a title recorded in the HQ or HSP recording mode, picture noise may appear depending upon the condition of the recording.
- Picture noise may appear depending upon the condition of the recording, or when playing a title recorded in the HQ or HSP recording mode. The picture freezes for a few seconds when you use fast forward/fast reverse or instant replay/advance.

Searching for a Title/ Chapter/Track, etc.

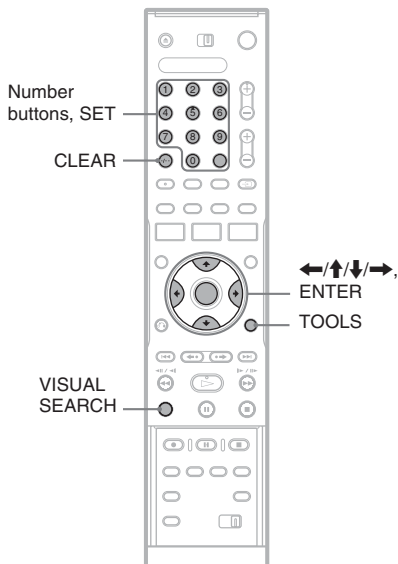

Searching by Thumbnail (Visual Search)

+RW -RW/VR -RW_Video +R -R

Each chapter is displayed as a thumbnail. You can search for the desired scene visually.

1 Press VISUAL SEARCH during playback.

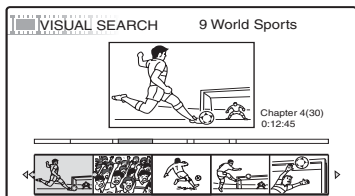

2 Select a scene using \leftarrow/\rightarrow , and press ENTER.

Playback of the selected scene is started.

Searching by title number or time code

+RW -RW/VR -RW_Video +R -R DVD
VCD CD DATA DVD DATA CD

You can search a disc by title, chapter, scene or track. As titles and tracks are assigned individual numbers, select the title or track by entering its number. You can also search for a scene using the time code.

1 Press TOOLS during playback to select a search method, and press ENTER.

- “Title Search” (for DVDs)
- “Chapter Search” (for DVDs)
- “Track Search” (for CDs/DATA CDs)
- “Search” (for VIDEO CDs)
- “Album Search” (for DATA DVDs/DATA CDs)
- “Time Search” (for DVDs): Searches for a starting point by entering the time code.
- “File Search” (for DATA DVDs/DATA CDs)

The display for entering the number appears.
Example: Title Search



The number in parentheses indicates the total number of titles, tracks, etc.

2 Press the number buttons to select the number of the title, chapter, track, time code, etc., you want.

For example: Time Search
To find a scene at 2 hours, 10 minutes, and 20 seconds, enter “21020.”

If you make a mistake, press CLEAR to cancel the number, then select another number.

3 Press SET.

The recorder starts playback from the selected number.

Playing MP3 Audio Tracks or JPEG Image Files

DATA DVD DATA CD

You can play MP3 audio tracks and JPEG image files on DATA CDs (CD-ROMs/CD-Rs/CD-RWs) or JPEG image files on DATA DVDs (DVD-ROMs/DVD+RWs/DVD+Rs/DVD-RWs/DVD-Rs).

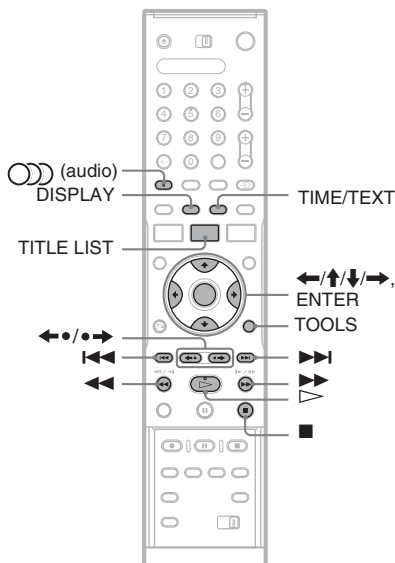

1 Insert a disc.

See “Inserting a Disc” on page 25.

2 Press .

For MP3 discs, playback starts from the first MP3 audio track on the disc.



For JPEG files, a slideshow of the pictures on the disc begins.

If the DATA CD contains both MP3 audio tracks and JPEG image files, playback starts from the JPEG image files the first time  is pressed.

Selecting an MP3 album or track

1 Press TITLE LIST.

The album list appears.

To change the page, press  .

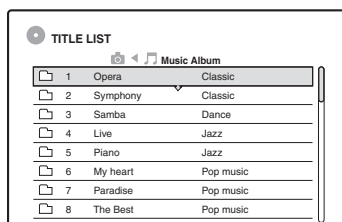



2 Select an album, and press ENTER.

The sub-menu appears.

3 Select “View Album,” and press ENTER.

The track list appears.

To change the page, press  .



4 Select a track, and press ENTER.

“Play”: Plays the track.



“Play Beginning”: Plays the beginning of the track.

“Track Data”: Shows data about the track such as artist and album name.





To stop playback

Press .

To fast forward or review a track

Press   during playback.

To go to the previous or next MP3 audio track

Press  or  during playback. If you repeatedly press  or , you will go to the previous or next album.

To go to the previous or next album

Press   during playback.

Hint

Press the  (audio) button to switch between stereo or monaural audio tracks.

Selecting a JPEG album or image

1 Press TITLE LIST.

The album list appears.

To change the page, press ◀•/•▶.

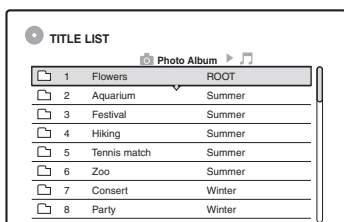

2 Select an album, and press ENTER.

The sub-menu appears.

3 Select "View Album," and press ENTER.

The image list appears.

To change the page, press ◀•/•▶.

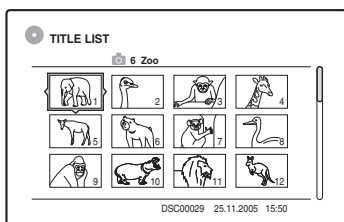

4 Select an image, and press ENTER.

"View Image": Shows the image on the entire screen.

"Slideshow": Shows the images in the album as a slideshow.

"Image Data": Shows data about when the picture was taken.

To stop viewing the JPEG image

Press ■.

To view the previous or next picture

Press ◀◀/▶▶ while the picture is displayed.

To rotate a picture

Press TOOLS while the image is displayed to select "Rotate Right" or "Rotate Left," and press ENTER.

To change the slideshow speed

Press TOOLS while the album list or image list is displayed to select "Slideshow Speed," and press ENTER. Then select the speed from "Fast" (quick), "Normal," and "Slow."

To go to the previous or next album

Press ◀•/•▶ while the JPEG image is displayed.

💡 Hints

- If you are playing a DATA CD that has both MP3 and JPEG files, you can switch between photo and music albums by using the ◀/▶ buttons when the album list is displayed.
- You can rotate a JPEG image by using the ◀/▶ buttons when the image is displayed.
- Press DISPLAY repeatedly to show information about the JPEG album or image on your TV screen. Then press TIME/TEXT to toggle between the current selected image number and album number.

📌 Notes

- If the DVD disc, such as a disc from a DVD video camera, contains both video and JPEG images, only the video can be played back.
- Some JPEG files, especially files of three million pixels or more, may lengthen the slideshow interval.
- Rotated JPEG images will not be saved when you press ■ or switch to another folder.
- Images larger than 720 × 480 will be reduced to 720 × 480 when displayed.
- Images larger than 4 mega bytes cannot be displayed.
- Progressive JPEG images cannot be displayed.
- When you attempt to play a broken file or a file that does not satisfy the play conditions, ⚠ appears but the recorder cannot play the file.

About MP3 audio tracks and JPEG image files

MP3 is audio compression technology that satisfies certain ISO/MPEG regulations. JPEG is image compression technology.

You can play MP3 (MPEG1 Audio Layer 3) format audio tracks and JPEG image files on DATA CDs (CD-ROMs/CD-Rs/CD-RWs) or JPEG image files on DATA DVDs (DVD-ROMs/DVD+RWs/DVD+Rs/DVD-RWs/DVD-Rs). DATA CDs must be recorded according to ISO9660 Level 1, Level 2 or Joliet format for the recorder to recognize the MP3 tracks. DATA DVDs must be recorded in Universal Disc Format (UDF). You can also play discs recorded in MultiSession.

See the instructions supplied with the CD-R/CD-RW/DVD-R/DVD-RW drives and the recording software (not supplied) for details on the recording format.

Note on MultiSession/Border discs

If MP3 audio tracks or JPEG image files are recorded in the first session/border, the recorder will also play MP3 audio tracks or JPEG image files in other sessions/borders. If audio tracks and images in Music CD format or Video CD format are recorded in the first session/border, only the first session/border will be played back.

Note

The recorder may not be able to play some DATA CDs/DATA DVDs created in the Packet Write format.

MP3 audio tracks or JPEG image files that the recorder can play

The recorder can play the following tracks and files:

- MP3 audio tracks with the extension “.MP3,” “.mp3,” or “.Mp3.”
- JPEG image files with the extension “.JPEG,” “.jpg,” “.JPG,” “.Jpg,” “.jpeg,” or “.Jpeg.”
- JPEG image files that conform to the DCF* image file format.

* “Design rule for Camera File system”: Image standards for digital cameras regulated by JEITA (Japan Electronics and Information Technology Industries Association).

Notes

- The recorder will play any data with the extension “.MP3,” “.mp3,” “.Mp3,” “.JPEG,” “.jpg,” “.JPG,” “.Jpg,” “.jpeg,” or “.Jpeg” even if they are not in MP3 or JPEG format. Playing these data may generate a loud noise which could damage your speaker system.
- The recorder does not conform to audio tracks in mp3PRO format.
- Some files cannot be played.
- The letters that cannot be displayed are replaced with “*.”

About playback order of albums, tracks, and files

Albums play in the following order:

Structure of disc contents

Tree 1 Tree 2 Tree 3 Tree 4 Tree 5

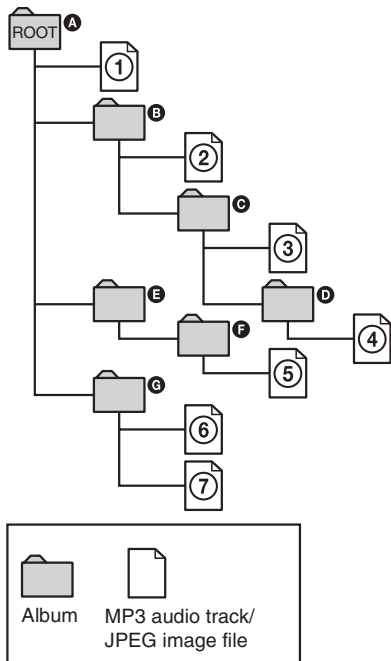

When you insert a DATA CD/DATA DVD and press \triangleright , the numbered tracks (or files) are played sequentially, from ① through ⑦. For JPEG image files, press $\bullet \rightarrow$ to go to the next album. (For instance, when you want to go from ① to ②.) Any sub-albums/tracks (or files) contained within a currently selected album take priority over the next album in the same tree. (Example: **C** contains **D** so ④ is played before ⑤.) When you press TITLE LIST and the list of album names appears (page 28), the album names are arranged in the following order: **A** \rightarrow **B** \rightarrow **C** \rightarrow **D** \rightarrow **F** \rightarrow **G**. Albums that do not contain tracks (or files) (such as album **E**) do not appear in the list.

💡 Hints

- If you add numbers (01, 02, 03, etc.) to the front of the track/file names when you store the tracks (or files) in a disc, the tracks and files will be played in that order.
- Since a disc with many trees takes longer to start playback, it is recommended that you create albums with no more than two trees.

⚡ Notes

- Depending on the software you use to create the DATA DVD/DATA CD, the playback order may differ from the above illustration.
- No more than a total of 199 individual folders can be played. (Folders that do not contain JPEG/MP3 files are counted as well.)
- No more than a total of 999 folders and files can be played. (Files other than JPEG/MP3 files, and folders that do not contain JPEG/MP3 files are counted as well.)
- No more than 200 folders and files can be recognized in a single folder. (Folders that do not contain JPEG/MP3 files are counted as well.)
- Proceeding to the next or another album may take some time.
- This recorder supports MP3 audio bit rates up to 160 kbps.

Before Editing

This recorder offers various edit options for various disc types. Before you edit, check the disc type in the front panel display, and select the option available for your disc (page 8).

⚡ Notes

- You may lose the edited contents if you remove the disc or a timer recording starts while editing.
- DVD discs created by DVD video cameras cannot be edited on this recorder.

Edit options for DVD-RWs (VR mode)

-RWVR

You can enjoy advanced edit functions. First you have two options for DVD-RWs (VR mode): editing either the original recording (called the “original”), or the playback information created from the original (called a “Playlist”). Since each is different in nature and offers different merits, read the following and select the one that better suits your needs.

To edit original titles

Edits made to the original titles are final. If you plan to retain an unaltered original recording, create and edit a Playlist (see below). The edit functions available for original titles are:

- Labelling a title (page 58).
- Setting protection against erasure (page 58).
- Erasing a title (page 58).
- Erasing multiple titles (page 60).
- Erasing a section of a title (A-B Erase) (page 59).
- Erasing all titles on the disc (page 60).
- Erasing a chapter (page 59).

To create and edit Playlist titles

A Playlist is a group of Playlist titles created from the original title for editing purposes. When you create a Playlist, only the control information necessary for playback, such as the playback order, is stored on the disc. Since the original titles are left unaltered, Playlist titles can be re-edited.

Example: You have recorded the final few matches of a football tournament on a DVD-RW (VR mode). You want to create a digest with the goal scenes and other highlights, but you also want to keep the original recording.

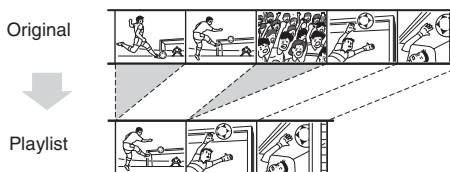

In this case, you can compile highlight scenes as a Playlist title. You can even rearrange the scene order within the Playlist title (“Creating and Editing a Playlist” on page 61).

The advanced edit functions available for Playlist titles are:

- Labelling a title (page 58).
- Erasing a title (page 58).
- Erasing multiple titles (page 60).
- Erasing a section of a title (A-B Erase) (page 59).
- Rearranging the title order (DVD-RWs (VR mode) only) (page 62).
- Combining multiple titles into one title (page 63).
- Erasing a chapter (page 59).

🔍 Hint

You can display the disc’s Playlist titles in the Title List (Playlist), or the original titles in the Title List (Original). To switch the two Title Lists, press TOOLS while a Title List is displayed, and select “Original” or “Playlist.”

⚡ Notes

- The Playlist title calls up data from the original titles for playback. When an original title is used for a Playlist title, the original title cannot be erased.
- If a message appears and indicates that the disc’s control information is full, erase or edit unnecessary titles.

Edit options for DVD+RWs/DVD-RWs (Video mode)/DVD+Rs/DVD-Rs

+RW -RW_{Video} +R -R

You can perform simple edits. Since Video mode titles are actual recordings on the disc, you cannot undo any edits you make. The edit functions available for Video mode titles are:

- Setting protection against erasure (page 58).
- Labelling a title (page 58).
- Erasing a title (page 58).
- Erasing multiple titles (page 60).
- Erasing a section of a title (A-B Erase) (DVD+RWs only) (page 59).
- Erasing all titles on the disc (page 60).
- Erasing titles to open up disc space (Disc Map) (DVD+RWs and DVD-RWs (Video mode) only) (page 60).

Notes

- When editing a DVD+R or DVD-R, finish all editing before finalizing the disc. You cannot edit a finalized disc.
- The available disc space does not increase even when you erase titles for DVD+Rs and DVD-Rs.
- If a message appears and indicates that the disc's control information is full, erase or edit unnecessary titles.

Erasing and Editing a Title

+RW -RW_{VR} -RW_{Video} +R -R

This section explains the basic edit functions. Note that editing is irreversible. To edit DVD-RWs (VR mode) without changing the original recordings, create a Playlist title (page 61).

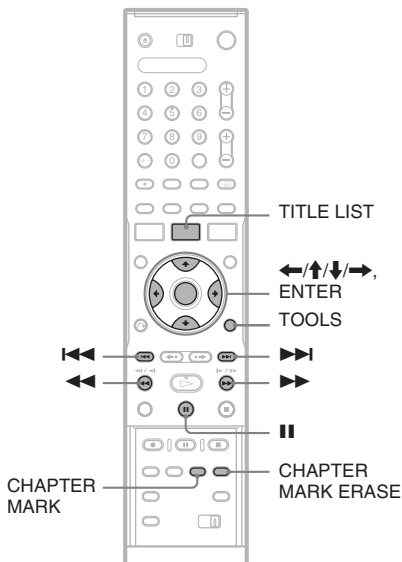

1 Press TITLE LIST.

For DVD-RWs in VR mode, press TOOLS and select “Original” or “Playlist” from the TOOLS menu to switch the Title Lists, if necessary.

2 Select a title, and press ENTER.

The sub-menu appears.

3 Select an option, and press ENTER.

You can make the following edits to the title. “Erase”: Erases the selected title. Select “OK” when asked for confirmation.

“Protect”: Protects the title. Select “On” when the Protection display appears. “” appears next to the protected title. To cancel the protection, select “Off.”

“Title Name”: Allows you to enter or re-enter a title name (page 32).

“Set Thumbnail”: Changes the title’s thumbnail picture that appears in the Title List (page 29).

“A-B Erase”: Erases a section of the title (page 59).

“Delete Chapter”: Erases chapter units of the title while viewing thumbnails (see below).

Hints

- You can erase multiple titles at one time (page 60), or erase all of the titles on the disc at once (page 60).
- You can automatically erase titles that have already played.
- You can label or re-label DVDs (page 33).



Note

DVD-RW (VR mode) playlist titles cannot be protected.

Erasing a chapter (Delete Chapter)

-RWVR

Thumbnails are displayed for each chapter. You can easily select and erase a section in a title. Note that erasing a chapter cannot be undone.

- 1 After step 2 of “Erasing and Editing a Title,” select “Delete Chapter,” and press ENTER.
- 2 Select a thumbnail of the chapter using  , and press ENTER.

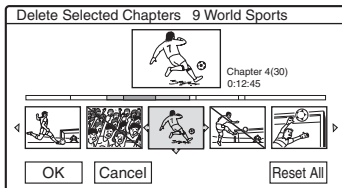

- To cancel the selection, press ENTER again.
 - To erase multiple chapters, repeat step 2.
 - To reset all selections, select “Reset All.”
- 3 Select “OK,” and press ENTER. The display asks for confirmation.
 - 4 Select “Yes,” and press ENTER.

Erasing a section of a title (A-B Erase)

+RW -RWVR

You can select a section (scene) in a title and erase it. Note that erasing scenes in a title cannot be undone.



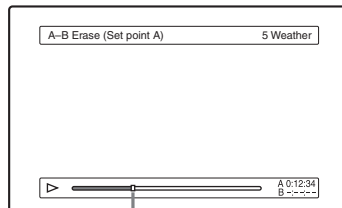

- 1 After step 2 of “Erasing and Editing a Title,” select “A-B Erase” and press ENTER.

The display for setting point A appears.

- To return to the beginning of the title, press  and then press .



Playback point

- 2 Select point A by pressing  , and press ENTER.
- 3 Select point B by pressing  , and press ENTER.

The display asks for confirmation.

- To reset either point A or B, select “Change A” or “Change B,” and go to step 2 or 3.
- To preview the title without scenes to be erased, select “Preview” (except for DVD+RWs).

- 4 Select “OK,” and press ENTER.

The scene is erased, and the display asks whether to erase another scene.

- To continue, select “Yes,” and repeat from step 2.
- To finish, select “No.”

Hint

A chapter mark is inserted after the scene was erased. The chapter mark divides the title into separate chapters on either side of the mark.

Notes

- Images or sound may be momentarily interrupted at the point where you erase a section of a title.
- Sections shorter than five seconds may not be erased.
- For DVD+RWs, the erased section may be slightly different from the points you selected.

Erasing multiple titles (Erase Titles)

+RW -RWVR -RWVideo +R -R

You can select and erase more than one title at one time using the TOOLS menu.

- 1 Press TITLE LIST.
- 2 Press TOOLS to select “Erase Titles,” and press ENTER.

The display for selecting titles to be erased appears.

- 3 Select a title, and press ENTER.

A check mark appears in the check box next to the selected title.

- To clear the check mark, press ENTER again.
- To clear all of check marks, select “Reset All.”

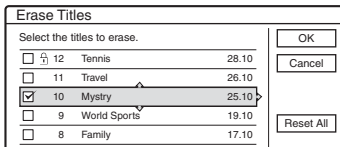

- 4 Repeat step 3 to select all of the titles you want to erase.

- 5 When you finish selecting titles, select “OK,” and press ENTER.

The list of the titles to be erased appears for confirmation.

- To change the selection, select “Change,” and repeat from step 3.

- 6 Select “OK” and press ENTER.

The titles are erased.

Erasing all titles on the disc

+RW -RWVR -RWVideo +R -R

- 1 Press TOOLS to select “Disc Info,” and press ENTER.

The “Disc Information” display appears.

- 2 Select “Erase All,” and press ENTER.

- 3 Select “OK,” and press ENTER.

All titles on the disc are erased (except the protected titles).

Erasing titles to open up disc space (Disc Map)

+RW -RWVideo

When recording on a DVD+RW or DVD-RW (Video mode), the recorder searches for the largest open space and records there. Before you start, check the disc status by using Disc Map, and erase titles to create a space large enough for the recording.

- 1 Insert a disc and press TITLE LIST.
- 2 Press TOOLS to select “Disc Map,” and press ENTER.

The “Disc Map” display appears.

- To check the open space, select the space by pressing ◀/▶.

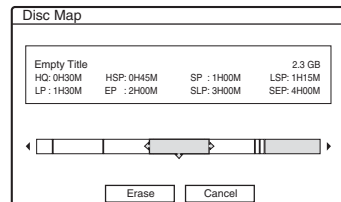

- When ◀ or ▶ appears on either side of the screen, you can scroll sideways by pressing ◀/▶.

3 Select a title by pressing ←/→, and press ENTER.

The display for selecting titles to be erased appears.

- To cancel the selection, press ENTER again.
- To erase more titles, repeat step 3.

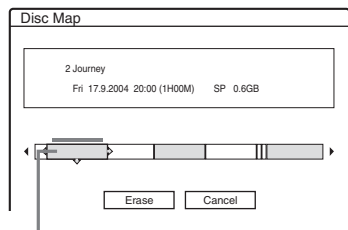

Selected title

4 Select “Erase,” and press ENTER.

The display asks for confirmation.

5 Select “OK,” and press ENTER.

The selected titles are erased, freeing up disc space.

- To change the selection, select “Change.”

Creating chapters manually

-RWVR

You can manually insert a chapter mark at any point you like during playback or recording.

Press CHAPTER MARK at the point where you want to divide the title into chapters.

Each time you press the button, “Marking...” appears on the screen and the scenes to the left and right of the mark become separate chapters.

To erase chapter marks

You can combine two chapters by erasing the chapter mark during playback.

Press ◀◀/▶▶ to search for a chapter number, and while displaying the chapter containing the chapter mark you want to erase, press CHAPTER MARK ERASE.

The current chapter combines with the previous chapter.

Note

To insert a chapter mark manually during recording, set “Auto Chapter” in “Features” setup to “Off.”

Creating and Editing a Playlist

-RWVR

Playlist edit allows you to edit or re-edit without changing the actual recordings. You can create up to 97 Playlist titles.

Note

Once you create a Playlist title from original titles, you will be unable to erase or edit the original titles.

1 Press TITLE LIST.

2 Press TOOLS to select “Create Playlist,” and press ENTER.

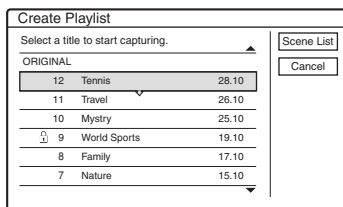

3 Select the title you want to include in the Playlist title, and press ENTER.

The sub-menu appears.

“Capture”: Adds a section of the title to the Playlist title as one scene.

“Capture All”: Adds the entire title to the Playlist title as one scene. After capturing the title, go to step 8.

4 Select “Capture,” and press ENTER.

The display for setting the start point (IN) appears. The title starts to play in the background.

- To return to the beginning of the title, press II and then press ◀◀.

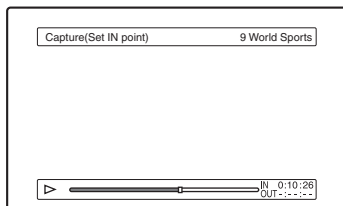

5 Select the IN point by pressing ◀◀/▶▶, and press ENTER.

The display for setting the end point (OUT) appears, and the title continues to play in the background.

6 Select the OUT point by pressing ◀◀/▶▶, and press ENTER.

The display asks for confirmation. To reset the IN or OUT point, select “Change IN” or “Change OUT” and repeat step 5 or 6. To view the selected scene, select “Preview.”

7 Select “OK,” and press ENTER.

The Scene List menu appears with all of the selected scenes.

Total duration of the selected scene Total number of scenes

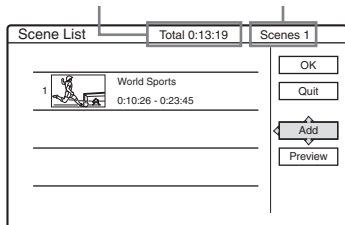

- To add more scenes, select “Add” and go to step 3.
- To preview all of the captured scenes in the listed order, select “Preview.”

8 Select the scene you want to re-edit, and press ENTER.

The sub-menu appears.
“Move”: Changes the scene order.
“Erase”: Erases the scene. The selection is cancelled.
“Preview”: Displays thumbnail pictures of the scenes.
“Change IN”: Allows you to change the IN point, and repeat from step 5.
“Change OUT”: Allows you to change the OUT point, and repeat from step 6.

9 When you finish editing the Scene List, select “OK,” and press ENTER.

The display for entering the title name appears. To enter a new name, select “Enter” (page 32).

10 Select “OK” to use the default name, and press ENTER.

To play the Playlist title

Press TOOLS while the Title List menu is turned on. Then, select “Playlist” and press ENTER. When the Title List (Playlist) menu appears, select a title and press ▷.

💡 Hint

When a Playlist title is created, the IN and OUT points will become chapter marks, and each scene will become a chapter.

⚡ Note

The picture may pause when the edited scene is played.

Moving a Playlist title (Change Order)

-RWVR

You can change the Playlist title order within the Title List (Playlist).

1 Press TITLE LIST to turn on the Title List (Playlist) menu.

If the Title List (Original) menu appears, press TOOLS and select “Playlist.”

2 Select the title you want to move, and press ENTER.

The sub-menu appears.

3 Select “Change Order,” and press ENTER.

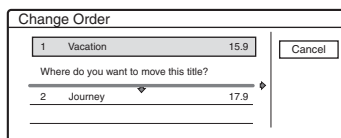

4 Select a new location for the title by pressing ↑/↓, and press ENTER.

The title moves to the new location.

Combining multiple Playlist titles (Combine)

-RWVr

1 Press TITLE LIST to turn on the Title List (Playlist) menu.

If the Title List (Original) menu appears, press TOOLS and select “Playlist.”

2 Press TOOLS to select “Combine,” and press ENTER.

The display for selecting titles appears.

3 Select a title, and press ENTER.

A number indicating the order in which you selected the title appears.

To cancel the selection, press ENTER again.

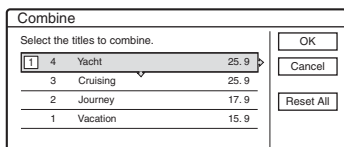

4 Repeat step 3 to select all of the titles you want to combine.

To cancel all of the selections, select “Reset All.”

5 Select “OK,” and press ENTER.

The list of titles to be combined appears.

To change the selection, select “Change” and go to step 3.

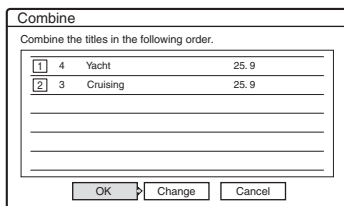

6 Select “OK,” and press ENTER.

The display for selecting a title name from among the selected titles appears.

To enter a new name, select “Enter Text,” and follow the explanations on page 32.

To change the selection, select “Change” and go to step 3.

7 Select a name, and press ENTER.

The titles are combined.

Note

When the number of chapters in the title to be combined exceeds the limit, the chapters at the end are combined into a single chapter.

Dividing a Playlist title (Divide)

-RWVr

You can divide a Playlist title.

1 Press TITLE LIST.

Press TOOLS and select “Original” or “Playlist” from the TOOLS menu to switch the Title Lists, if necessary.

2 Select a title, and press ENTER.

The sub-menu appears.

3 Select “Divide,” and press ENTER.

The display for setting the dividing point appears. The title starts to play in the background.

- To return to the beginning of the title, press **II** and then press **◀◀**.

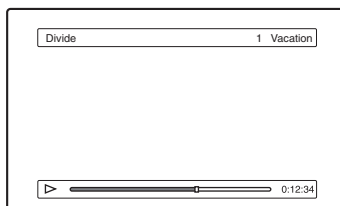

4 Select the dividing point by pressing ◀▶, and press ENTER.

The display asks for confirmation.

- To change the dividing point, select “Change.”

5 Select “OK,” and press ENTER.

The display for entering the title name appears.

- To use the same title name as before, select “No.”

6 Select “Yes,” and press ENTER to enter a new name.

Follow the explanations on page 32. After you enter a new name, the title is divided in two.

Before DV Dubbing

This section explains dubbing with a digital video camera via the DV IN jack on the front panel. If you want to dub by way of the LINE IN jacks, see “Recording from connected equipment without a timer” on page 45.

To record from the DV IN jack

The DV IN jack on this recorder conforms to the i.LINK standard. You can connect any other equipment that has an i.LINK (DV) jack, and record digital signals.

Follow the instructions in “Preparing for DV dubbing,” and then move on to the section on dubbing. For more information about i.LINK, see “About i.LINK” on page 87.

Hint

If you plan to do additional editing on a disc after the initial dub, use the DV IN jack and record on a DVD-RW (VR mode).

Preparing for DV dubbing

You can connect a digital video camera to the DV IN jack on the recorder to record or edit from a DV/Digital 8 format tape. Operation is straightforward because the recorder will fast forward and rewind the tape for you – you do not need to operate your digital video camera. Do the following to start using the “DV Edit” functions of this recorder.

See the instruction manual supplied with the digital video camera as well before connecting.

Notes

- The DV IN jack is for input only. It will not output signals.
- You cannot use the DV IN jack when:
 - your digital video camera does not work with this recorder. Connect the camera to the LINE IN jack and follow the instructions of “Recording from connected equipment without a timer” on page 45.
 - the input signal is not in DVC-SD format. Do not connect a MICRO MV format digital video camera even if it has an i.LINK jack.
 - the images on the tape contain copy protection signals, which limit recording.
- If you want to play the disc on other DVD equipment, finalize the disc (page 34).

Hookups

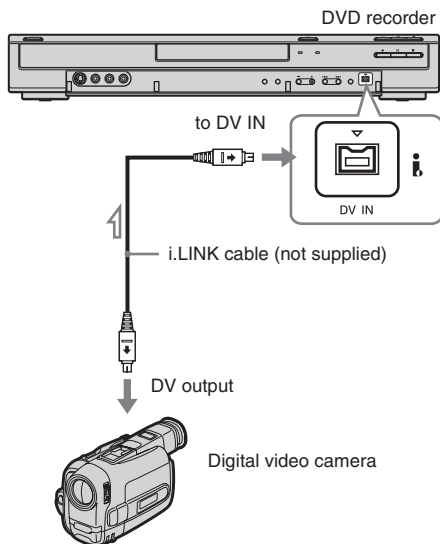

 : Signal flow

- 1 Insert a disc.**
See “Inserting a Disc” on page 25.
- 2 Insert the source DV/Digital 8 format tape into your digital video camera.**
For the recorder to record or edit, your digital video camera must be set to video playback mode.
- 3 Press INPUT SELECT on the remote repeatedly to select “DV.”**
The front panel display changes as follows:

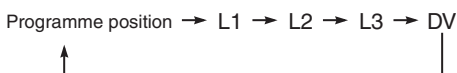

4 Press REC MODE on the remote repeatedly to select the recording mode.

The recording mode changes as follows:



For details about the recording mode, see page 36.

5 Press TOOLS on the remote to select “DV Audio Input,” and press ENTER. Then, select the setting for the audio input.

“Stereo1” (default): Records original sound only. Normally select this when dubbing a DV format tape.

“Mix”: Records both stereo 1 and 2.

“Stereo2”: Records additional audio only.

Select “Mix” or “Stereo2” only if you have added a second audio channel when recording with your digital video camera.

You are ready to start dubbing. Select one of the dubbing methods on the following pages.

Hints

- You can turn off the recorder during dubbing. The recorder completes dubbing even after being turned off.
- You can adjust the settings for the recording picture before recording. See “Adjusting the recording picture quality and size” on page 40.

Notes

- You cannot connect more than one piece of digital video equipment to the recorder.
- You cannot control the recorder using another device or another recorder of the same model.
- You cannot record date, time, or the contents of the cassette memory onto the disc.
- If you record from a DV/Digital 8 format tape that is recorded in multiple sound tracks, such as a tape with multiple sampling frequencies (48 kHz, 44.1 kHz, or 32 kHz), no sound or an unnatural sound will be output when playing back the sampling frequency switch point on the disc.
- In order to use this recorder’s “Auto Chapter” setting (page 65, 66), be sure to correctly set the clock on your digital video camera before shooting.
- The recorded picture may be momentarily affected if the picture size of the source image changes, or if there is nothing recorded on the tape.

Recording an Entire DV Format Tape (One Touch Dubbing)

+RW **-RWVR** **-RWVideo** **+R** **-R**

You can record the entire contents of a DV/Digital8 format tape onto a disc with a single press of the ONE-TOUCH DUB button on the recorder. The recorder controls the digital video camera for the whole process, and completes the recording.

◆ How chapters are created

The contents dubbed to DVD become a single title. When “Auto Chapter” of “Features” setup is set to “On,” this title is divided into chapters. When dubbing a DVD-RW (VR mode), each shooting session on the tape becomes a chapter on the disc. For other discs, the recorder divides the title into chapters at approximately 6-minute intervals.

Follow steps 1 to 5 of “Preparing for DV dubbing” on page 64, and press ONE-TOUCH DUB on the recorder.

The recorder rewinds the tape and then starts recording the tape contents.

When the recording is finished, the recorder rewinds the tape in the digital video camera.

To stop during recording

Open the remote’s cover and press **■ REC STOP**. Note that it may take a few seconds for the recorder to stop recording.

Hint

If you set “Finalize Disc” of “One Touch Dubbing” to “Auto” in “Features” setup (page 77), the recorded disc (except DVD-RW (VR mode)) will automatically be finalized after recording is finished.

Notes

- When a blank space between the recordings on the tape continues for more than five minutes, One Touch Dubbing ends automatically.
- The recorder records a blank for five minutes before it stops dubbing. To stop the blank recording, press **■ REC STOP**.

Program Edit

+RW **-RW/VR** **-RW/Video** **+R** **-R**

You can select scenes from a DV/Digital8 format tape, and then automatically record selected scenes to a DVD.

To use this function, you will do the following:

Connect your digital video camera and prepare for recording



Select and edit the scenes you want to dub

Using the recorder's remote control, fast forward or rewind the tape to select the scenes. At this point, the selected scenes are not copied to the disc. The recorder only remembers the IN and OUT points of the scenes that you selected for dubbing. You can also reset, erase, or change the order of the scenes.



Dub the selected scenes

After you have selected the scenes, the recorder will fast forward and rewind the tape automatically and record the scenes to a DVD.

◆ How chapters are created

The contents dubbed to DVD become a single title. When "Auto Chapter" of "Features" setup is set to "On," this title is divided into chapters. When dubbing to a DVD-RW (VR mode), each shooting session on the tape becomes a chapter on the disc. For other discs, the recorder divides the title into chapters at approximately 6-minute intervals.

1 Follow steps 1 to 5 of "Preparing for DV dubbing" on page 64, and press **SYSTEM MENU**.

2 Select "DV EDIT," and press **ENTER**.

The display asks if you want to start selecting scenes.

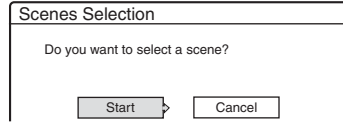

- If you have previously saved a programme, the display asks if you want to edit an existing programme or to create a new programme. To resume editing the existing programme, select "Saved Data," and go to step 6.

3 Select "Start," and press **ENTER**.

The display for setting the IN point (start of the scene) appears.

The scene starts to play in the background.

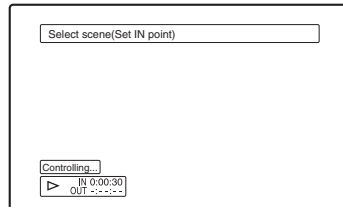

4 Select the IN point by pressing **◀◀/▶▶**, and press **ENTER**.

The display for setting the OUT point (end of the scene) appears. The scene starts to play in the background from the IN point.

5 Select the OUT point by pressing **◀◀/▶▶**, and press **ENTER**.

The display asks if you want to add the selected scene to the Scene List menu.

To preview the scene, select "Preview."

To reset either the IN or OUT point, select "Change IN" or "Change OUT," and repeat from step 4.

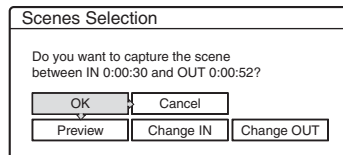

6 Select “OK,” and press ENTER.

A new Scene List menu appears with the selected scene.

To add a scene, select “Add.”

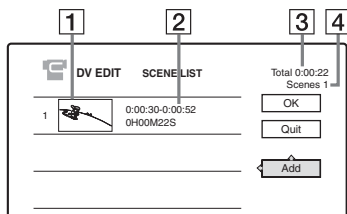

- 1 Thumbnail picture
- 2 Time information
- 3 Total duration of the program
- 4 Total number of scenes

7 When you finish adding scenes, select the scene you want to edit, and press ENTER.

The sub-menu appears.

“Move”: Changes the scene order. Follow the explanations on the screen to change the order by pressing \uparrow/\downarrow and ENTER.

“Erase”: Erases the scene. When asked for confirmation, select “OK.”

“Preview”: Plays the selected scene.

“Change IN”: Changes the start of the scene. Repeat from step 4.

“Change OUT”: Changes the end of the scene. Repeat from step 5.

8 When you finish editing the Scene List, select “OK,” and press ENTER.

The display for entering the title name appears. To enter a new name, select “Enter,” and follow the explanations on page 32.

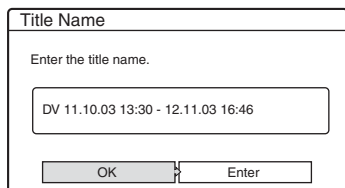

9 Select “OK,” and press ENTER.

The default title name is fixed, and the display asks if you want to start recording.

To change the dubbing mode, select “Dub Mode” and press \uparrow/\downarrow .

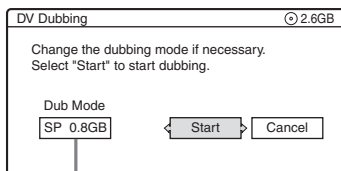

Data capacity required for the dubbing

10 Select “Start,” and press ENTER.

The recorder starts recording the tape contents as programmed.

- If the recording does not fit due to the dubbing mode you selected, the display asks if you want to continue.

To change the dubbing mode, select “Reset” and repeat from step 9.

To have the recorder adjust the dubbing mode, select “Auto Dub Mode.”

- If there is not enough disc space even after changing the dubbing mode, the display asks if you want to record halfway.

To continue, select “OK.”

To stop during recording

Open the remote’s cover and press \blacksquare REC STOP. Note that it may take a few seconds for the recorder to stop recording.

Notes

- Contents recorded to a DVD may not be recorded as programmed if the tape’s time code is not sequential or there are blanks between the recordings on the tape. In this case, see “Recording from connected equipment without a timer” on page 45.
- The start and end points of a programme may be different from what you have set if the source DV/Digital 8 format tape is in any of the following conditions:
 - Recording mode was changed during the recording.
 - There is a blank space in the recorded portion of the tape.
- If you set the beginning of the tape as the IN point and the end point as the OUT point, the IN and OUT points may move slightly during dubbing.
- You cannot set a scene to be shorter than one second.

Aerial Reception and Language Settings (Settings)

The “Settings” setup helps you to make tuner, clock, and programme position settings for the recorder.

1 Press **SYSTEM MENU** while the recorder is in stop mode.

2 Select “**SETUP**,” and press **ENTER**.

3 Select “**Settings**,” and press **ENTER**.

The options of “Settings” appear. The default settings are underlined.

To turn off the display, press **SYSTEM MENU** repeatedly.

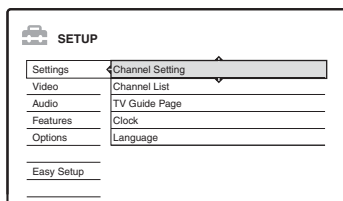

Channel Setting

Presets programme positions manually.

If some programme positions could not be set using the “Easy Setup” function, you can set them manually.

If there is no sound or if the picture is distorted, the wrong tuner system may have been preset during “Easy Setup.” Set the correct tuner system manually in the steps below.

1 Select “**Channel Setting**” in “**Settings**,” and press **ENTER**.

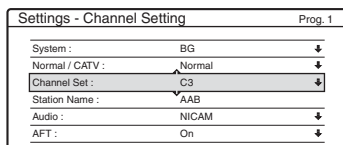

2 Press **PROG +/-** to select the programme position.

Selected programme position

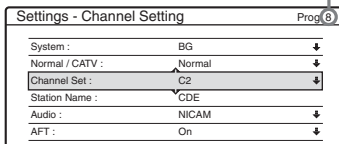

3 Select “**System**,” and press **ENTER**.

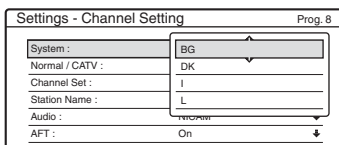

4 Select an available TV system, BG, DK, I, or L, and press **ENTER** (page 69).

BG	<ul style="list-style-type: none"> • Malaysia, Singapore, Thailand • Middle East • Australia, New Zealand
DK	• CIS
I	<ul style="list-style-type: none"> • Hong Kong • South Africa
L	Do not select this.

5 Select “**Normal/CATV**,” and press **ENTER**.

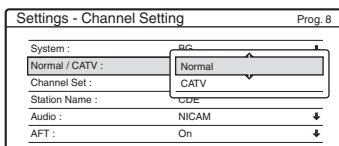

6 Select “**Normal**,” and press **ENTER**.
To set CATV (Cable Television) channels, select “**CATV**.”

7 Select “**Channel Set**,” and press **ENTER**.

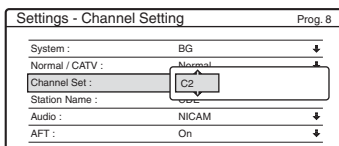

- 8 Press \uparrow/\downarrow repeatedly until the channel you want is displayed, then press ENTER. The channels are scanned in the order shown in the table on page 69.

- If you know the number of the channel you want, press the number buttons. For example, for channel 5, first press “0” and then press “5.” Then press ENTER.

- 9 Select “Audio,” and press ENTER.

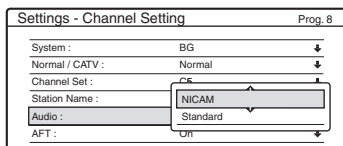

NICAM	Normally, select this.
Standard	Select this if the sound from NICAM broadcasts is not clear.

- 10 Select “NICAM,” and press ENTER.

- 11 Select “AFT” and press ENTER.

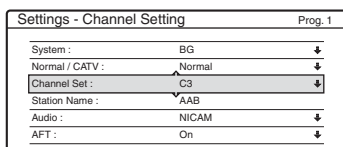

On	Turns on the Auto Fine Tuning function. Normally, select this.
Off	Allows you to adjust the pictures manually.

- 12 Select “On” to turn on AFT, and press ENTER.

- If the Auto Fine Tuning function does not work effectively, select “Off” and press ENTER. When the fine tuning bar appears, press \leftarrow/\rightarrow to obtain a clearer picture, and press ENTER.
- To preset another channel, repeat from step 2.

◆ Receivable channels

TV system	Channel coverage
BG	E2 - E12 VHF
• Malaysia, Singapore, Thailand	A - H VHF
• Middle East	AS0 - AS12 VHF
• Australia, New Zealand	NZ1 - NZ11 VHF
	E21 - E69 UHF
	AS28 - AS69 UHF
	S1 - S20 CATV
	S1 - S46 CATV
	S21 - S41 HYPER
	S01 - S05 CATV
DK	R1 - R12 VHF
• CIS	R21 - R69 UHF
	S1 - S20 CATV
	S21 - S41 HYPER
	S01 - S05 CATV
I	A - J VHF
• Hong Kong	4 - 13 VHF
• South Africa	B21 - B69 UHF
	S1 - S20 CATV
	S21 - S41 HYPER
	S01 - S05 CATV

Station Name

Changes or enters a new station name (up to 5 characters). The recorder must receive channel information for station names to appear automatically.

- 1 Select “Channel Setting” in “Settings,” and press ENTER.

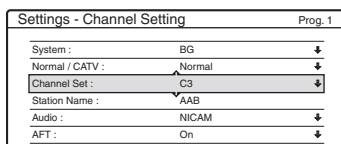

- 2 Press PROG +/- to select the programme position for which you want to change or enter a station name.

- 3 Select “Station Name,” and press ENTER. The display for entering characters appears.

To enter characters, see page 32.

- 4 Select “Finish,” and press ENTER.

Channel List (Changing/Disabling the channels)

Changes or disables the programme positions after setting the channels. If any programme positions are unused or contain unwanted channels, you can disable them.

You can also change station names. If the station names are not displayed, you can enter them manually.

- 1 Select “Channel List” in “Settings,” and press ENTER.

Prog	Channel	Name
1	C3	AAB
2	C5	FGH
3	C12	
4	C21	
5	C23	
6	C24	PQR

- 2 Press \uparrow/\downarrow to select the row containing the programme position you want to change or disable.

To change, press ENTER and go to step 3.

To disable, press CLEAR and go to step 5.

The disabled positions will be skipped when you press PROG +/-.

To display other pages for programme positions 7 to 99, press \uparrow/\downarrow repeatedly.

- 3 Press \uparrow/\downarrow until the selected channel row moves to the desired programme position. The selected channel is inserted at the new programme position.

Prog	Channel	Name
1	C3	AAB
2	C12	
3	C21	
4	C5	FGH
5	C23	
6	C24	PQR

- 4 Press ENTER to confirm the setting.

- 5 To change or disable the programme position of another station, repeat from step 2.

Note

Be sure to correctly select the programme position you want to disable. If you disable the wrong programme position by mistake, you need to reset that channel manually.

TV Guide Page

Some broadcast systems ensure a Teletext service* in which the complete programmes and their data (title, date, channel, recording start time, etc.) are stored day by day. A TV guide page corresponds to each day of the week. When recording a programme, the recorder automatically takes the programme name from the Teletext pages and stores it as the title name. The TV guide page numbers depend entirely on the broadcast itself and may be subject to change. If so, you may have to set those TV guide page numbers manually in the TV Guide Page menu.

* This feature mostly likely cannot be used because it requires a service that is provided in limited areas only.

- 1 Select "TV Guide Page" in "Settings," and press **→** or **ENTER**.
The TV Guide Page menu appears.
- 2 Select the programme position for which you want to set or change the TV guide page by pressing **PROG +/-**.
 - The TV guide page numbers (Example: P301) appear automatically when the recorder detects them.

Settings - TV Guide Page		Prog. 4
Sun	P 301	↓
Mon	P 302	↓
Tue	P 303	↓
Wed	P 304	↓
Thu	P 305	↓
Fri	P 306	↓
Sat	P 307	↓

- If no page numbers are detected (P000), you have to set the appropriate TV guide page number manually.

Settings - TV Guide Page		Prog. 4
Sun	P 000	↓
Mon	P 000	↓
Tue	P 000	↓
Wed	P 000	↓
Thu	P 000	↓
Fri	P 000	↓
Sat	P 000	↓

- 3 Select the TV guide page number you want to modify, and press **ENTER**.

Settings - TV Guide Page		Prog. 4
Sun	P 000	↓
Mon	P 000	↓
Tue	P 000	↓
Wed	P 000	↓
Thu	P 000	↓
Fri	P 000	↓
Sat	P 000	↓

- 4 Press the number buttons or **←/↑/↓/→** to enter the TV guide page number, and press **ENTER** to confirm the setting.

- If you make a mistake, press **CLEAR** to re-enter the correct number.

To set or change another TV guide page number, repeat steps 3 and 4 above.

Hint

To view Teletext information on your TV screen during a broadcast, switch to your TV's tuner by pressing **TV/VIDEO** (page 18).

Notes

- In step 4 above, enter "000" if you do not want to use the TV guide page number for automatic labelling. The recorder will instead store a default title name (programme position, start time - stop time).
- Refer to the Teletext information on your TV screen to obtain the TV guide page number with programme titles and their start times.
- If the Teletext TV guide has a page which always shows the programmes for the current day, this page should be input for all days.
- If you start recording more than three minutes before the programme is scheduled to start, the correct label information may not be transferred.
- Note that this function may not work correctly with programmes broadcast from some stations.
- If the broadcast system updates the Teletext information at the moment recording starts, the title label may not correspond to the recorded programme. In this case, you may have to manually enter the correct title (page 32).

Clock

Auto Adjust (Auto Clock Set)

This function cannot be used in your area.

Present Time (Manual Clock Set)

Set the clock manually.

- 1 Select "Clock" in "Settings," and press **ENTER**.
- 2 Select "Present Time," and press **ENTER**.
- 3 Press **↑/↓** to set the month, and press **→**.
Set the day, year, hour, and minutes in sequence. Press **←/→** to select the item to be set, then press **↑/↓** to set the numbers. The day of the week is set automatically.
- 4 Press **ENTER** to start the clock.

Hint

To change the numbers in step 3, press **←** to return to the item to be changed, and select the numbers by pressing **↑/↓**.

Language

OSD (On-Screen Display)

Switches the display language on the screen.

DVD Menu (DVD VIDEO only)

Switches the language for the DVD menu.

Audio (DVD VIDEO only)

Switches the language of the sound track.

When you select "Original," the language given priority in the disc is selected.

Subtitle (DVD VIDEO only)

Switches the language of the subtitles recorded on the disc.

When you select "Audio Follow," the subtitle language changes according to the language you selected for the sound track.

Hint

If you select "Others" in "DVD Menu," "Subtitle," or "Audio," select and enter a language code from "Language Code List" on page 94 using the number buttons.

Note

If you select a language in "DVD Menu," "Subtitle," or "Audio" that is not recorded on the DVD VIDEO, one of the recorded languages will be automatically selected.

Video Settings (Video)

Video settings will adjust items related to the image, such as size and colour.

Choose the settings according to the type of TV, tuner, or decoder connected to the DVD recorder.

1 Press **SYSTEM MENU** while the recorder is in stop mode.

2 Select "**SETUP**," and press **ENTER**.

3 Select "**Video**," and press **ENTER**.

The "Video" setup appears with the following options. The default settings are underlined.

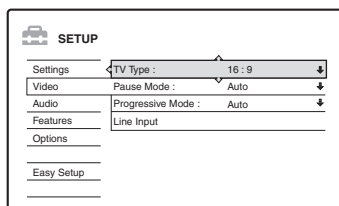

TV Type

Sets the picture size when playing back a title recorded from 16:9 size video (page 40) or a 16:9 size commercial DVD video.

Select the playback picture size according to the type of connected TV (wide-screen/wide mode TV or conventional 4:3 screen TV).

<u>16:9</u>	Select this when connecting to a wide-screen TV or TV with a wide mode function.
4:3 Letter Box	Select this when connecting to a 4:3 screen TV. Displays a wide picture with bands on the upper and lower portions of the screen.
4:3 Pan Scan	Select this when connecting to a 4:3 screen TV. Automatically displays a wide picture on the entire screen and cuts off the portions that do not fit.

16:9



4:3 Letter Box



4:3 Pan Scan



Note

Depending on the disc, “4:3 Letter Box” may be selected automatically instead of “4:3 Pan Scan” or vice versa.

Pause Mode (DVDs only)

Selects the picture quality in pause mode.

<u>Auto</u>	The picture, including subjects that move dynamically, is output with no jitter. Normally select this position.
Frame	The picture, including subjects that do not move dynamically, is output in high resolution.

Progressive Mode

DVD software can be divided into two types: film based software and video based software. Video based software is derived from TV, such as dramas and sit-coms, and displays images at 30 frames/60 fields (25 frames/50 fields) per second. Film based software is derived from film and displays images at 24 frames per second. Some DVD software contains both Video and Film. In order for these images to appear natural on your screen when output in progressive mode (50 or 60 frames per second), the progressive video signal needs to be converted to match the type of DVD software that you are watching.

You can fine-tune the progressive 525p/625p video signal that is output when you press PROGRESSIVE (“PROGRESSIVE” lights up). Note that you must connect to a progressive format TV using the COMPONENT VIDEO OUT jacks (page 14).

<u>Auto</u>	Automatically detects the software type (Film-based or Video-based) and selects the appropriate conversion mode. Normally select this position.
Video	Fixes the conversion mode to the mode for Video-based software.

Line Input

Sets the method of inputting video signals from the LINE IN jacks on the rear panel of the recorder. Select an option for each of the items below according to the combination of jacks and methods that you are going to use.

◆ Line1 Input

Selects a method of inputting video signals for the LINE IN 1 jack on the rear panel of the recorder.

<u>Video</u>	Inputs video signals.
S Video	Inputs S video signals.

◆ Line3 Input

Selects the method of inputting video signals for the LINE IN 3 jack on the rear panel of the recorder. The pictures will not be clear if this setting does not match the type of video input signal.

<u>Video</u>	Inputs video signals.
S Video	Inputs S video signals.

Audio Settings (Audio)

The “Audio” setup allows you to adjust the sound according to the playback and connection conditions.

1 Press **SYSTEM MENU** while the recorder is in stop mode.

2 Select “**SETUP**,” and press **ENTER**.

3 Select “**Audio**,” and press **ENTER**.

The “Audio” setup appears with the following options. The default settings are underlined.

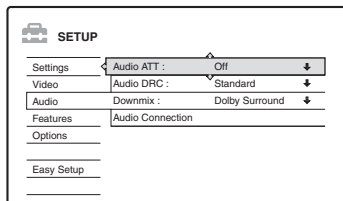

Audio ATT (attenuation)

If the playback sound is distorted, set this item to “On.” The recorder reduces the audio output level. This function affects the output of the following jacks:

– LINE OUT R-AUDIO-L jacks

<u>On</u>	Select this when the playback sound from the speakers is distorted.
<u>Off</u>	Normally select this position.

Audio DRC (Dynamic Range Control) (DVDs only)

Makes the sound clear when the volume is turned down when playing a DVD that conforms to “Audio DRC.” This affects the output from the following jacks:

- LINE OUT R-AUDIO-L jacks
- DIGITAL OUT (OPTICAL or COAXIAL) jack only when “Dolby Digital” is set to “D-PCM” (page 75).

<u>Standard</u>	Normally select this position.
TV Mode	Makes low sounds clear even if you turn the volume down.
Wide Range	Gives you the feeling of being at a live performance.

Downmix (DVDs only)

Switches the method for mixing down to two channels when you play a DVD which has rear sound elements (channels) or is recorded in Dolby Digital format. For details on the rear signal components, see “4. Displaying the Playing Time and Play Information” on page 30. This function affects the output of the following jacks:

- LINE OUT R-AUDIO-L jacks
- DIGITAL OUT (OPTICAL or COAXIAL) jack when “Dolby Digital” is set to “D-PCM” (page 75).

<u>Dolby Surround</u>	Normally select this position. Multi-channel audio signals are output to two channels for enjoying surround sounds.
Normal	Multi-channel audio signals are downmixed to two channels for use with your stereo.

Audio Connection

The following setup items switch the method of outputting audio signals when you connect a component such as an amplifier (receiver) with a digital input jack.

For connection details, see “Step 4: Connecting the Audio Cords” on page 16.

Select “Dolby Digital,” “MPEG,” “DTS,” and “48kHz/96kHz PCM” after setting “Digital Out” to “On.”

If you connect a component that does not accept the selected audio signal, a loud noise (or no sound) will come out from the speakers, and may affect your ears or cause speaker damage.

- 1 Select “Audio Connection” in “Audio,” and press ENTER.

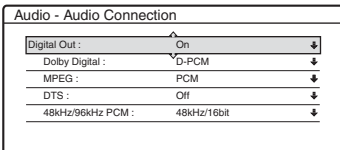

- 2 Select “Digital Out,” and press ENTER.

<u>On</u>	Normally select this position.
Off	The influence of the digital circuit upon the analogue circuit is minimal.

- 3 Select “On,” and press ENTER.

- 4 Set the digital output signal.

- **Dolby Digital (DVDs only)**

Selects the type of Dolby Digital signal.

<u>D-PCM</u>	Select this when the recorder is connected to an audio component lacking a built-in Dolby Digital decoder. The surround effects of output signals are determined by the “Downmix” setting item in “Audio” setup.
Dolby Digital	Select this when the recorder is connected to an audio component with a built-in Dolby Digital decoder.

- **MPEG (DVD VIDEO only)**

Selects the type of MPEG audio signal.

<u>PCM</u>	Select this when the recorder is connected to an audio component without a built-in MPEG decoder. If you play MPEG audio sound tracks, the recorder outputs stereo signals via the DIGITAL OUT (OPTICAL or COAXIAL) jack.
MPEG	Select this when the recorder is connected to an audio component with a built-in MPEG decoder.

- **DTS (DVD VIDEO only)**

Selects whether or not to output DTS signals.

<u>On</u>	Select this when the recorder is connected to an audio component with a built-in DTS decoder.
Off	Select this when the recorder is connected to an audio component without a built-in DTS decoder.

- **48kHz/96kHz PCM (DVD VIDEO only)**

Selects the sampling frequency of the audio signal.

<u>48kHz/ 16bit</u>	The DVD video audio signal is converted to 48kHz/16bit and output.
96kHz/ 24bit	All signals containing 96kHz/24bit are output without conversion. However, the signals are output at 48kHz/16bit if copyright-protected signals are contained.

⚡ Notes

- “48kHz/96kHz PCM” setting has no effect when audio signals are output from the LINE OUT (R-AUDIO-L) jacks. If the sampling frequency is 96kHz, signals are simply converted to 96kHz analog signals and output.
- When you use the DIGITAL OUT (OPTICAL or COAXIAL) jack to listen to MPEG audio signals and set “MPEG” to “MPEG” in “Audio” setup, no sound will come from your speakers if you select one of the TVS modes.

Recording and Parental Control Settings (Features)

The “Features” setup allows you to adjust recording and parental control settings.

1 Press **SYSTEM MENU** while the recorder is in stop mode.

2 Select **“SETUP,”** and press **ENTER**.

3 Select **“Features,”** and press **ENTER**.

The “Features” setup appears with the following options. The default settings are underlined.

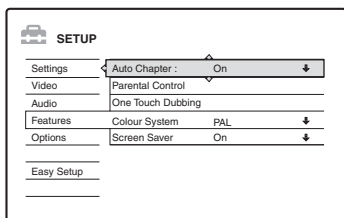

Auto Chapter

Selects whether to automatically divide a recording (a title) into chapters during recording or dubbing.

<u>On</u>	For a DVD-RW (VR mode), the recorder detects changes in the picture and sound and automatically inserts chapter marks. For other recordable discs, the recorder inserts chapter marks at approximately 6-minute intervals.
Off	No chapter mark is inserted.

Notes

- The actual chapter mark interval may vary depending on the amount of information contained in the video to be recorded.
- Chapter marks are automatically inserted where the recordings start on the tape when “Auto Chapter” is set to “On” during DV dubbing to a DVD-RW (VR mode).

Parental Control (DVD VIDEO only)

Playback of some DVD VIDEOS can be limited according to a predetermined level, such as the age of the users. Scenes may be blocked or replaced with different scenes.

1 Select “Parental Control” in “Features,” and press **ENTER**.

- If you have not entered a password, the display for registering a new password appears.

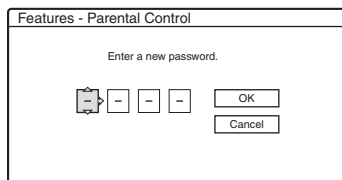

- When you have already registered a password, the display for entering the password appears.

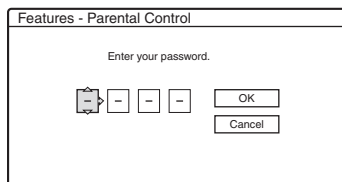

2 Enter your four-digit password using the number buttons, then select **“OK”** and press **ENTER**.

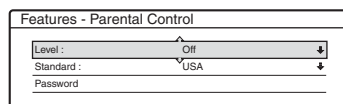

3 Select **“Standard,”** and press **→** or **ENTER**. The selection items for “Standard” are displayed.

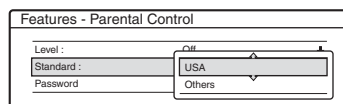

4 Select a geographic area as the playback limitation level, and press **ENTER**. The area is selected.

- When you select “Others,” press the number buttons to select and enter an area code in the table (page 94). Then select **“OK”** and press **ENTER**.

- 5 Select “Level,” and press ENTER.
The selection items for “Level” are displayed.

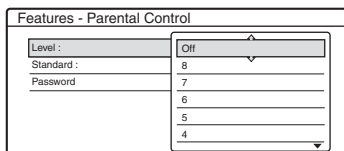

The lower the value, the stricter the limitation. Discs rated higher than the selected level will be restricted.

- 6 Select the level, and press ENTER.
The Parental Control setting is complete.

To cancel the Parental Control setting for the disc, set “Level” to “Off” in step 6.

To change the password, select “Password” in step 3, and press ENTER. When the display for registering a password appears, enter a new four-digit password using the number buttons, then select “OK” and press ENTER.

Notes

- If you forget your password, you will have to reset it by selecting “Parental Control” of “Factory Setup” in “Options” setup (page 79).
- When you play discs which do not have the Parental Control function, playback cannot be limited on this recorder.
- Depending on the disc, you may be asked to change the Parental Control level while playing the disc. In this case, enter your password, then change the level.

One Touch Dubbing

Displays the following options for the One Touch Dub function.

◆ Finalize Disc (for all recordable discs except DVD-RW in VR mode)

Selects whether or not to finalize the disc automatically following One Touch Dubbing (page 65).

Auto	Automatically finalizes the disc following One Touch Dubbing.
<u>Manual</u>	Allows you to finalize the disc manually.

Colour System

Selects the colour system when playing VIDEO CDs (including Super VIDEO CDs).

<u>PAL</u>	Plays a disc in PAL colour system.
NTSC	Plays a disc in NTSC colour system.

Screen Saver

The screen saver image appears when you do not use the recorder for more than 10 minutes while an on-screen display, such as the System Menu, is displayed on your TV screen. The screen saver image helps prevent your display device from becoming damaged (ghosting).

<u>On</u>	Turns on the screen saver function.
Off	Turns off the function.

Disc and Remote Control Settings/Factory Settings (Options)

The “Options” setup allows you to set up other operational settings.

1 Press **SYSTEM MENU** while the recorder is in stop mode.

2 Select “**SETUP**,” and press **ENTER**.

3 Select “**Options**,” and press **ENTER**.

The “Options” setup appears with the following options. The default settings are underlined.

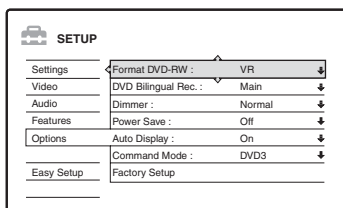

Format DVD-RW (DVD-RW only)

The recorder automatically starts formatting in VR mode or Video mode, whichever is selected below, when a new, unformatted DVD-RW is inserted.

<u>VR</u>	Automatically formats the disc in VR mode.
Video	Automatically formats the disc in Video mode.

DVD Bilingual Rec. (for all recordable discs except DVD-RW in VR mode)

Selects the sound to be recorded on the recordable disc. This setting is not necessary when recording on DVD-RWs (VR mode) that record both the main and sub sounds.

<u>Main</u>	Records the main sound for the bilingual programme.
Sub	Records the sub sound for the bilingual programme.

Dimmer

Adjusts the lighting of the front panel display.

<u>Normal</u>	Bright lighting.
Power Save	Low lighting. Turns off the lighting when the power is off.

Note

When “Power Save” in “Options” setup is set to “On,” the front panel display is turned off during standby regardless of this setting.

Power Save

Selects whether this recorder is in power save mode when the power is turned off (standby).

<u>On</u>	Sets to power save mode. The front panel display is off when the recorder is in standby.
Off	Does not set to power save mode. Normally, select this.

Note

Power Save mode does not function while Synchro Recording is set, even when “Power Save” is set to “On.”

Auto Display

<u>On</u>	Automatically displays information on the screen when the recorder is turned on, etc.
Off	Displays information only when DISPLAY is pressed.

Command Mode

Changes the Command Mode of the recorder if other DVD equipment is assigned the same Command Mode. Be sure to match the Command Mode switch on the remote to the setting made here. For details, see “If you have a Sony DVD player or more than one Sony DVD recorder” on page 20.

DVD1	Select this if the default Command Mode conflicts with other DVD equipment.
DVD2	Select this if the default Command Mode conflicts with other DVD equipment.
<u>DVD3</u>	The default Command Mode of the recorder.

Factory Setup

Allows you to select the setup settings by group, and return them to their default settings. Note that all of your previous settings will be lost.

- 1 Select “Factory Setup” in “Options,” and press **→** or **ENTER**.
The display for selecting a group of settings appears.
- 2 Select the group of settings you want to return to default from “Settings,” “Video,” “Audio,” “Features,” “Options,” “Parental Control,” and “All,” and press **→** or **ENTER**.
- 3 Select “Start,” and press **ENTER**.
The selected settings return to their default settings.
- 4 Press **ENTER** when “Finish” appears.

Easy Setup (Resetting the Recorder)

Select this to run the “Easy Setup” programme.

- 1 Press **SYSTEM MENU** while the recorder is in stop mode.
- 2 Select “**SETUP**,” and press **ENTER**.
- 3 Select “**Easy Setup**,” and press **ENTER**.

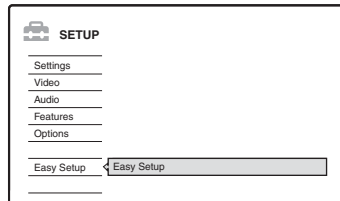

- 4 Press **ENTER**.
- 5 Select “**Start**.”
- 6 Follow the instructions for “**Easy Setup**” (page 21) from step 2.

Additional Information

Troubleshooting

If you experience any of the following difficulties while using the recorder, use this troubleshooting guide to help remedy the problem before requesting repairs. Should any problem persist, consult your nearest Sony dealer.

Power

The power does not turn on.

- ➔ Check that the power cord (mains lead) is connected securely.

Picture

There is no picture.

- ➔ Re-connect all connecting cords securely.
- ➔ The connecting cords are damaged.
- ➔ Check the connection to your TV (page 13).
- ➔ Switch the input selector on your TV (such as to "VCR") so that the signal from the recorder appears on the TV screen.
- ➔ This recorder cannot record NTSC signals.
- ➔ When playing a double-layer DVD, the video and audio may be momentarily interrupted at the point where the layers switch.

Picture noise appears.

- ➔ If the picture output signal from your recorder passes through your VCR to get to your TV, or if you are connected to a combination TV/VIDEO player, the copy-protection signal applied to some DVD programmes could affect picture quality. If you still experience this problem even when you connect your recorder directly to your TV, try connecting your recorder to your TV's S VIDEO input.
- ➔ You have set the recorder to progressive format (the PROGRESSIVE indicator lights up) even though your TV cannot accept the progressive signal. In this case, press PROGRESSIVE until the PROGRESSIVE indicator turns off.

- ➔ Even if your TV is compatible with progressive format (525p/625p) signals, the image may be affected when you set the recorder to progressive format. In this case, press PROGRESSIVE so that the PROGRESSIVE indicator turns off and the recorder is set to normal (interlace) format.
- ➔ You are playing a DVD recorded in a colour system that is different from your TV.
- ➔ When playing a double-layer DVD, the video and audio may be momentarily interrupted at the point where the layers switch.

TV programme reception does not fill the screen.

- ➔ Set the channel manually in "Channel Setting" in "Settings" setup (page 68).
- ➔ Select the correct source using the INPUT SELECT button, or select a channel of any TV programme using the PROG +/- buttons.

TV programme pictures are distorted.

- ➔ Reorient the TV aerial.
- ➔ Adjust the picture (see the TV's instruction manual).
- ➔ Place the recorder and TV farther apart.
- ➔ Place the TV and any bunched aerial cables farther apart.
- ➔ The RF cable is connected to the AERIAL OUT jack on the recorder. Connect the cable to the AERIAL IN jack.

TV channels cannot be changed.

- ➔ The channel is disabled (page 70).
- ➔ A timer recording started, which changed the channels.

The picture from equipment connected to the recorder's input jack does not appear on the screen.

- ➔ If the equipment is connected to the LINE IN 1 jacks, select "L1" in the front panel display by pressing PROG +/- or INPUT SELECT.
If the equipment is connected to the LINE 2 IN jacks, select "L2" in the front panel display by pressing PROG +/- or INPUT SELECT.
If the equipment is connected to the LINE IN 3 jacks, select "L3" in the front panel display by pressing PROG +/- or INPUT SELECT.
If the equipment is connected to the DV IN jack, (this is usually for a digital video camera connection), select "DV" in the front panel display by pressing PROG +/- or INPUT SELECT.

The playback picture or TV programme from the equipment connected through the recorder is distorted.

- ➔ If the playback picture output from a DVD player, VCR, or tuner goes through your recorder before reaching your TV, the copy-protection signal applied to some programmes could affect picture quality. Disconnect the playback equipment in question and connect it directly to your TV.

The picture does not fill the screen.

- ➔ Set “TV Type” in “Video” setup in accordance with the screen size of your TV (page 72).

The picture does not fill the screen, even though the picture size is set in “TV Type” in “Video” setup.

- ➔ The picture size of the title is fixed.

Sound

There is no sound.

- ➔ Re-connect all connections securely.
- ➔ The connecting cord is damaged.
- ➔ The input source setting on the amplifier or the connection to the amplifier is incorrect.
- ➔ The recorder is in reverse play, fast-forward, slow motion, or pause mode.
- ➔ If the audio signal does not come through the DIGITAL OUT (OPTICAL or COAXIAL) jacks, check the “Audio Connection” settings in “Audio” setup (page 75).

Sound distortion occurs.

- ➔ Set “Audio ATT” in “Audio” setup to “On” (page 74).

Sound is noisy.

- ➔ When playing a CD with DTS sound tracks, noise will come from the LINE OUT R-AUDIO-L jacks (page 49).

The sound volume is low.

- ➔ The sound volume is low on some DVDs. The sound volume may improve if you set “Audio DRC” in “Audio” setup to “TV Mode” (page 74).
- ➔ Set “Audio ATT” in “Audio” setup to “Off” (page 74).
- ➔ One of the TVS effects is selected (page 48).

An alternate audio track cannot be recorded.

- ➔ When recording from connected equipment, set “Line Audio Input” in TOOLS menu to “Bilingual” (page 45).
- ➔ Multilingual tracks (main and sub) cannot be recorded on DVD+RWs, DVD-RWs (Video mode), DVD+Rs, or DVD-Rs. To record the language, select “Main” or “Sub” of “DVD Bilingual Rec.” in “Options” setup before recording (page 78). To record both the main and sub sounds, record on a DVD-RW (VR mode).
- ➔ Any discs other than DVD-RWs (VR mode) cannot be used for recording both main and sub sounds.
- ➔ If you have connected an AV amplifier to the DIGITAL OUT (OPTICAL or COAXIAL) jacks and want to change the audio track for a DVD-RW (VR mode) during playback, set “Dolby Digital” of “Audio Connection” in “Audio” setup to “D-PCM” (page 75).

Playback

The recorder does not play any type of disc.

- ➔ The disc is upside down. Insert the disc with the labelled side facing up.
- ➔ The disc is not correctly inserted.
- ➔ Moisture has condensed inside the recorder. Remove the disc and leave the recorder turned on for about half an hour until the moisture evaporates.
- ➔ If the disc was recorded on another recorder, the recorder cannot play the disc if it was not finalized (page 34).

The recorder does not start playback from the beginning.

- ➔ Resume play was activated (page 47).
- ➔ You have inserted a DVD whose Title menu or DVD menu automatically appears on the TV screen when it is first inserted. Use the menu to start playback.

The recorder starts playing automatically.

- ➔ The DVD VIDEO features an auto playback function.

Playback stops automatically.

- ➔ If the DVD has an auto pause signal, the recorder stops playback at the auto pause signal.

Some functions such as Stop, Search, or Slow-motion Play cannot be performed.

- ➔ Depending on the DVD, you may not be able to do some of the operations above. See the instruction manual supplied with the disc.

The language for the sound track cannot be changed.

- ➔ Multilingual tracks are not recorded on the DVD being played.
- ➔ The DVD VIDEO prohibits the changing of the language for the sound track.
- ➔ Try changing the language using the DVD VIDEO's menu.

The subtitle language cannot be changed or turned off.

- ➔ Multilingual subtitles are not recorded on the DVD VIDEO.
- ➔ The DVD VIDEO prohibits changing of the subtitles.
- ➔ Try changing the subtitle using the DVD VIDEO's menu.
- ➔ The subtitles cannot be changed for the titles recorded on this recorder.

The angles cannot be changed.

- ➔ Multi-angles are not recorded on the DVD VIDEO being played.
- ➔ You are trying to change the angles when “” does not appear on the TV screen (page 48).
- ➔ The DVD VIDEO prohibits changing angles.
- ➔ Try changing the angle using the DVD VIDEO's menu.
- ➔ The angles cannot be changed for the titles recorded on this recorder.

The MP3 audio tracks do not play.

- ➔ The MP3 audio tracks are not recorded in a format that the recorder can play (page 53).

The JPEG image files do not play.

- ➔ The JPEG image files are not recorded in a format that the recorder can play (page 53).
- ➔ Progressive JPEG images cannot be played.

Recording/Timer recording/ Editing

The programme position cannot be changed from the programme position you are recording.

- ➔ Set the TV's input source to “TV.”

Recording does not start immediately after you press ● REC.

- ➔ Operate the recorder only after “LOAD,” “FORMAT,” or “INFOWRITE” disappears from the front panel display.

Nothing was recorded even though you set the timer setting correctly.

- ➔ There was a power failure during recording.
- ➔ The recorder's internal clock stopped due to a power failure that lasted for more than 1 hour. Reset the clock (page 71).
- ➔ The channel was disabled after the timer recording was set. See “Channel Setting” on page 68.
- ➔ Disconnect the power cord (mains lead) from the mains, and connect it again.
- ➔ The programme contains copy protection signals that restrict copying.
- ➔ Other timer setting overlapped the timer setting (page 43).
- ➔ There is no DVD inside the recorder.
- ➔ There is not enough disc space for the recording.
- ➔ The recorder was in the process of DV Dubbing.

Recording does not stop immediately after you press ■ REC STOP.

- ➔ It will take a few seconds for the recorder to input disc data before recording can stop.

Recording does not stop after you press ■.

- ➔ Open the remote's cover and press ■ REC STOP.

Timer recording is not complete or did not start from the beginning.

- ➔ There was a power failure during recording. If the power recovers when there is a timer recording, the recorder resumes recording. Should the power failure continue for more than 1 hour, reset the clock (page 71).
- ➔ Other timer setting overlapped the timer setting (page 43).
- ➔ Disc space was not enough.

Contents previously recorded were erased.

- ➔ Data that has been recorded on a DVD with a PC will be erased from the disc when the disc is inserted.
- ➔ The title was updated and recorded over (page 37).

Recording from the equipment with a timer**Nothing was recorded even though you set the Synchro-Rec setting correctly.**

- ➔ You forgot to turn off the connected equipment. Turn off the connected equipment and set the recorder to Synchro-Rec standby mode (page 43).
- ➔ The recorder was not set to the Synchro-Recording standby mode. Press SYNCHRO REC to have the recorder stand by for recording. Make sure the SYNCHRO REC indicator lights up on the front panel (page 43).
- ➔ The recorder is connected to the TV output jack of the connected equipment.

Synchro-Recording does not complete.

- ➔ The timer setting for the connected equipment overlapped the recorder's timer setting (page 44).
- ➔ There was a power failure during the recording.

The recorder automatically starts recording when the satellite receiver is turned on.

- ➔ The Synchro-Rec function was activated. Turn off the satellite receiver and cancel the Synchro-Rec function (page 43).

Display**The clock has stopped.**

- ➔ Set the clock again (page 71).
- ➔ The clock stopped due to a power failure that lasted for more than 1 hour. Reset the clock (page 71).

The TIMER REC indicator is flashing.

- ➔ The disc does not have enough space.
- ➔ Insert a recordable disc inside the recorder.

The recording mode indication is incorrect.

- ➔ When the recording or dubbing is less than three minutes, the recording mode indication may be displayed incorrectly. The actual recording itself is correctly made in the selected recording mode.
- ➔ After playing titles recorded in SLP and SEP mode, the recording mode indication may change depending on the recorded programme.

The clock does not appear in the front panel display.

- ➔ "Dimmer" in "Options" setup is set to "Power Save" (page 78).
- ➔ The "Power Save" in "Options" setup was set to "On," and the recorder is in standby (page 78).

Remote control**The remote does not function.**

- ➔ Batteries are weak.
- ➔ The remote is too far from the recorder.
- ➔ The remote's manufacturer code returned to the default setting when you replaced the batteries. Reset the code (page 18).
- ➔ Turn on the recorder.
- ➔ The remote is not pointed at the remote sensor on the recorder.
- ➔ Different command modes are set for the recorder and remote. Set the same command mode (page 20). The default command mode setting for this recorder and the supplied remote is DVD3.
- ➔ Set the TV/DVD switch to DVD (page 19).

Other Sony equipment responds to the remote.

- ➔ The same command mode is set for both the equipment and recorder. Set a different command mode for the recorder (page 20).

Others**The recorder does not operate properly.**

- ➔ Restart the recorder. Press down  on the recorder for more than ten seconds until "WELCOME" appears in the front panel display.
- ➔ When static electricity, etc., causes the recorder to operate abnormally, turn off the recorder and wait until the clock appears in the front panel display. Then, unplug the recorder and after leaving it off for a while, plug it in again.

Five numbers or letters are displayed in the front panel display.

- ➔ The self-diagnosis function was activated (see the table on page 84).

The disc tray does not open after you press  (open/close).

- ➔ It may take a few seconds for the disc tray to open after you have recorded or edited a DVD. This is because the recorder is adding disc data to the disc.

The disc tray does not open and “TRAY LOCKED” appears in the front panel display.

- ➔ Contact your Sony dealer or local authorized Sony service facility.



“RECOVERY” appears in the front panel display.

- ➔ The recorder’s recovery function was activated when the recorder was turned on because the power was turned off or failed during recording. Leave the recorder on until “RECOVERY” disappears from the front panel display.

“FAN ERROR” appears in the front panel display.

- ➔ Check that the vent on the rear of the recorder is not blocked. Then, immediately disconnect the AC power cord (mains lead). Leave the recorder off for a while, then re-connect the power cord (mains lead), and press  on the recorder.

The disc tray does not open and you cannot remove the disc after you press  (open/close).

- ➔ Turn off the recorder. Once the clock appears in the front panel display, disconnect the power cord (mains lead). (If the recorder does not turn off or if the clock does not appear in the front panel display, disconnect the power cord (mains lead) anyway.) Connect the power cord (mains lead) again while pressing down  on the recorder, and release the button when the disc tray opens. Then, keep  on the recorder pressed for about ten seconds until “WELCOME” appears in the front panel display.

“LOCKED” appears in the front panel display.

- ➔ The disc tray is locked. Cancel the Child Lock (page 47).

Self-diagnosis Function (When letters/numbers appear in the display)

When the self-diagnosis function is activated to prevent the recorder from malfunctioning, a five-character service number (e.g., C 13 00) with a combination of a letter and four numbers appears in the front panel display. In this case, check the following table.

First three characters of the service number	Cause and/or corrective action
C 13	The DVD is dirty. ➔ Clean the disc with a soft cloth.
C 31	The DVD/CD is not inserted correctly. ➔ Re-insert the disc correctly.
E XX (xx is a number)	To prevent a malfunction, the recorder has performed the self-diagnosis function. ➔ Contact your nearest Sony dealer or local authorized Sony service facility and give the five-character service number. Example: E 61 10

Notes About This Recorder

On operation

- If the recorder is brought directly from a cold to a warm location, or is placed in a very damp room, moisture may condense on the lenses inside the recorder. Should this occur, the recorder may not operate properly. In this case, remove the disc and leave the recorder turned on for about half an hour until the moisture evaporates.
- When you move the recorder, take out any discs. If you don't, the disc may be damaged.

On adjusting volume

Do not turn up the volume while listening to a section with very low level inputs or no audio signals. If you do, the speakers may be damaged when a peak level section is played.

On cleaning

Clean the cabinet, panel, and controls with a soft cloth slightly moistened with a mild detergent solution. Do not use any type of abrasive pad, scouring powder or solvent such as alcohol or benzine.

On cleaning discs

Do not use a commercially available cleaning disc. It may cause a malfunction.

Notes about the discs

- To keep the disc clean, handle the disc by its edge. Do not touch the surface. Dust, fingerprints, or scratches on the disc may cause it to malfunction.



- Do not expose the disc to direct sunlight or heat sources such as hot air ducts, or leave it in a car parked in direct sunlight as the temperature may rise considerably inside the car.
- After playing, store the disc in its case.

- Clean the disc with a cleaning cloth. Wipe the disc from the centre out.



- Do not use solvents such as benzine, thinner, commercially available cleaners, or anti-static spray intended for vinyl LPs.
- Do not use the following discs.
 - A disc that has a non-standard shape (e.g., card, heart).
 - A disc with a label or sticker on it.
 - A disc that has cellophane tape or sticker adhesive on it.

Specifications

System

Laser: Semiconductor laser

Channel coverage:

PAL/SECAM (B/G, D/K, I, L)
VHF: E2 to E12, R1 to R12, F2 to F10, Italian
A to H, Ireland A to J, South Africa 4 to 13/
UHF: E21 to E69, R21 to R69, B21 to B69,
F21 to F69/CATV: S01 to S05, S1 to S20,
France B to Q/HYPER: S21 to S41

For details, see "Receivable channels" (page 69).
The above channel coverage merely ensures the
channel reception within these ranges. It does not
guarantee the ability to receive signals in all
circumstances.

Video reception: Frequency synthesizer system

Audio reception: Split carrier system

Aerial out: 75-ohm asymmetrical aerial socket

Timer: Clock: Quartz locked/Timer indication:
24-hour cycle (digital)/Power back-up
duration: 1 hour

Video recording format: MPEG Video

**Audio recording format/applicable bit
rate:** Dolby Digital 2 ch/256 kbps

Inputs and outputs

LINE OUT

(AUDIO): Phono jack/2 V_{rms}/10 kilohms

(VIDEO): Phono jack/1.0 V_{p-p}

(S VIDEO): 4-pin mini DIN/Y:1.0 V_{p-p},
C: 0.3 V_{p-p} (PAL)

LINE IN 1/2/3

(AUDIO): Phono jack/2 V_{rms}/more than
22 kilohms

(VIDEO): Phono jack/1.0 V_{p-p}

(S VIDEO): 4-pin mini DIN/Y:1.0 V_{p-p},
C: 0.3 V_{p-p} (PAL)

DV IN: 4-pin/i.LINK S100

DIGITAL OUT (OPTICAL): Optical output jack/
-18 dBm (wave length: 660 nm)

DIGITAL OUT (COAXIAL): Phono jack/
0.5 V_{p-p}/75 ohms

COMPONENT VIDEO OUT

(Y, P_B/C_B, P_R/C_R):

Phono jack/Y: 1.0 V_{p-p}, P_B/C_B: 0.7 V_{p-p},
P_R/C_R: 0.7 V_{p-p}

General

Power requirements: 220-240 V AC,
50/60 Hz

Power consumption: 31 W

Dimensions (approx.): 430 × 65 × 328 mm
(width/height/depth) incl. projecting parts

Mass (approx.): 4.1 kg

Operating temperature: 5°C to 35°C

Operating humidity: 25% to 80%

Supplied accessories:

Audio/video cord (1)
Power cord (mains lead) (1)
Aerial cable (1)
Remote commander (remote) (1)
R6 (size AA) batteries (2)

Specifications and design are subject to change
without notice.

Compatible colour systems

This recorder is designed to record using the PAL
colour system and play back using the PAL or
NTSC colour systems.

The signals of the SECAM colour system can be
received or recorded but played back in the PAL
colour system only. Recording of video sources
based on other colour systems cannot be
guaranteed.

About i.LINK

The DV IN jack on this recorder is an i.LINK-compliant DV IN jack. This section describes the i.LINK standard and its features.

What is i.LINK?

i.LINK is a digital serial interface for handling digital video, digital audio and other data in two directions between equipment having the i.LINK jack, and for controlling other equipment.

i.LINK-compatible equipment can be connected by a single i.LINK cable. Possible applications are operations and data transactions with various digital AV equipment. When two or more i.LINK-compatible equipment are connected to this recorder in a daisy chain, operations and data transactions are possible with not only the equipment that this recorder is connected to but also with other devices via the directly connected equipment.

Note, however, that the method of operation sometimes varies according to the characteristics and specifications of the equipment to be connected, and that operations and data transactions are sometimes not possible on some connected equipment.

Note

Normally, only one piece of equipment can be connected to this recorder by the i.LINK cable (DV connecting cable). When connecting this recorder to i.LINK-compatible equipment having two or more i.LINK jacks (DV jacks), see the instruction manual of the equipment to be connected.

About the name “i.LINK”

i.LINK is a more familiar term for IEEE 1394 data transport bus proposed by SONY, and is a trademark approved by many corporations. IEEE 1394 is an international standard standardized by the Institute of Electrical and Electronics Engineers.

i.LINK baud rate

i.LINK's maximum baud rate varies according to the equipment. Three maximum baud rates are defined:

S100 (approx. 100 Mbps*)

S200 (approx. 200 Mbps)

S400 (approx. 400 Mbps)

The baud rate is listed under “Specifications” in the instruction manual of each equipment. It is also indicated near the i.LINK jack on some equipment.

The maximum baud rate of equipment on which it is not indicated such as this unit is “S100.”

When units are connected to equipment having a different maximum baud rate, the baud rate sometimes differs from the indicated baud rate.

* What is Mbps?

Mbps stands for megabits per second, or the amount of data that can be sent or received in one second. For example, a baud rate of 100 Mbps means that 100 megabits of data can be sent in one second.

i.LINK functions on this recorder

For details on how to dub when this recorder is connected to other video equipment having DV jacks, see page 64.

The DV jack on this recorder can only input DVC-SD signals. It cannot output signals. The DV jack will not accept MICRO MV signals from equipment such as a MICRO MV digital video camera with an i.LINK jack.

For further precautions, see the notes on page 64. For details on precautions when connecting this recorder, also see the instruction manuals for the equipment to be connected.

Required i.LINK cable

Use the Sony i.LINK 4-pin-to-4-pin cable (during DV dubbing).

i.LINK and  are trademarks.



Guide to Parts and Controls

For more information, see the pages in parentheses.

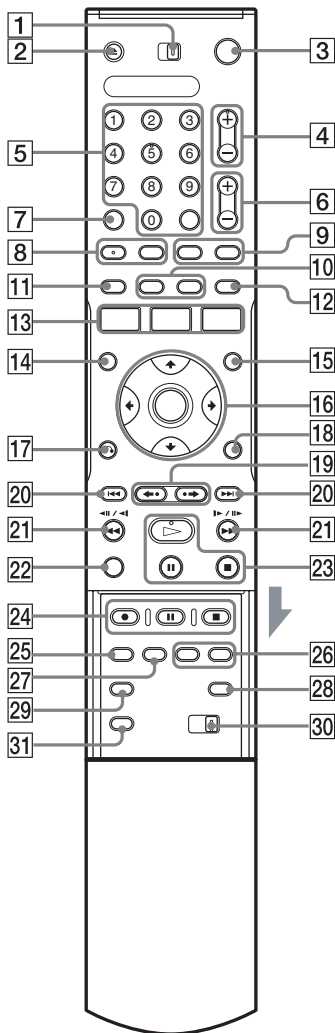
Remote











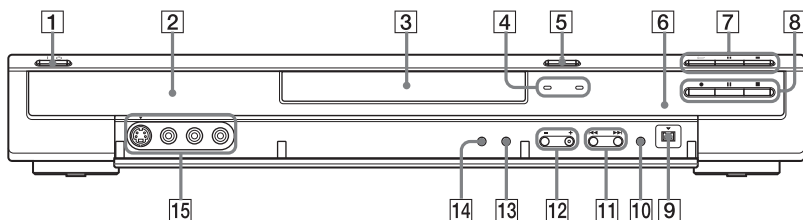

- 1** TV/DVD switch (18)
- 2** ▲ (open/close) button (25)
- 3** I/⏻ (on/standby) button (21)
- 4** PROG (programme) +/- buttons (27)
The + button has a tactile dot*.
- 5** Number buttons (39, 52)
SET button (39)
The number 5 button has a tactile dot*.
- 6** ▽ (volume) +/- buttons (18)
- 7** CLEAR/-/- (ten digit) button (39)
- 8** ○○○ (audio) button (48)
⋮ (subtitle) button (48)
The ○○○ (audio) button has a tactile dot*.
- 9** INPUT SELECT button (45, 64)
↻ TV/VIDEO button (18)
- 10** DISPLAY button (30)
TIME/TEXT button (30)
- 11** [TIMER] button (37, 39)
- 12** SUR (surround) button (48)
- 13** SYSTEM MENU button (66, 68)
TITLE LIST button (28, 46, 53, 58)
TIMER LIST button (42)
- 14** TOP MENU button (46)
- 15** MENU button (46)
- 16** ←/↑/↓/→/ENTER button (21)
- 17** ↶ RETURN button (42)
- 18** TOOLS button (25)
- 19** ◀• (instant replay)/▶• (instant advance) buttons (28, 53)
- 20** ◀◀/▶▶ (previous/next) buttons (48)
- 21** ◀◀◀◀/▶▶▶▶ (search) buttons (48)
- 22** VISUAL SEARCH button (52)

- 23 ▷ (play) button (46)
 - ▬▬ (pause) button (48)
 - (stop) button (46)The ▷ button has a tactile dot*.
- 24 ● REC button (27)
 - ▬▬ REC PAUSE button (27)
 - REC STOP button (27)
- 25 REC MODE button (27)
- 26 CHAPTER MARK/CHAPTER MARK
ERASE buttons (61)
- 27 SYNCHRO REC buttons (43)
- 28  (wide mode) button (18)
- 29  (angle) button (48)
- 30 COMMAND MODE switch (DVD 1,2,3)
(20)
- 31 PROGRESSIVE button (15)

* Use the tactile dot as a reference when operating the recorder.

Front panel



- 1 I/O (on/standby) button (21)
- 2 Front panel display (31, 91)
- 3 Disc tray (25)
- 4 TIMER REC indicator (37)
SYNCHRO REC indicator (43)
- 5  (open/close) button (25)
- 6  (remote sensor) (18)
- 7  (play) button (46)
 (pause) button (48)
 (stop) button (46)
- 8  REC button (27)
 REC PAUSE button (27)
 REC STOP button (27)
- 9  DV IN jack (64)
- 10 ONE-TOUCH DUB button (65)
- 11  (previous/next) buttons (48)
- 12 PROGRAM +/- buttons (27)
The + button has a tactile dot*.
- 13 INPUT SELECT button (45, 64)
- 14 REC MODE button (36)
- 15 LINE 2 IN (S VIDEO/VIDEO/L(MONO) AUDIO R) jacks (22)

* Use the tactile dot as a reference when operating the recorder.

Front panel display

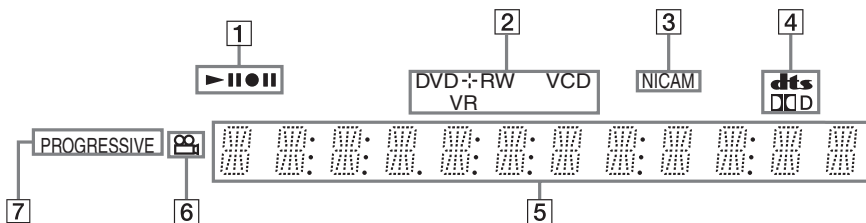

- 1** Playing/recording status
- 2** Disc type*/recording format
- 3** NICAM indicator (36)
- 4** Audio signal indicators (30)
- 5** Displays the following (31):
 - Playing time/remaining time
 - Current title/chapter/track/index number
 - Recording time/recording mode
 - Clock
 - Programme position
- 6**  (angle) indicator (48)
- 7** PROGRESSIVE indicator (15)

* Displays DATA CDs as “CD.”

Hint

You can turn off the front panel display when the recorder is turned off by setting “Dimmer” to “Power Save” in “Options” setup (page 78).

Rear panel

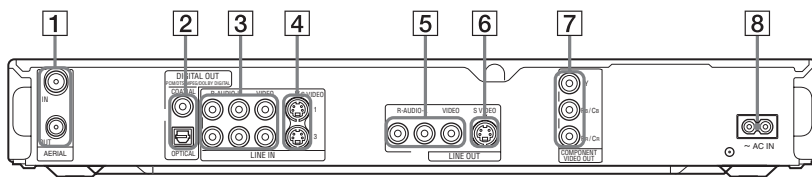

- 1** AERIAL IN/OUT jacks (13)
- 2** DIGITAL OUT (COAXIAL/OPTICAL) jacks (16)
- 3** LINE IN 1/3 (R-AUDIO-L/VIDEO) jacks (22)
- 4** LINE IN 1/3 (S VIDEO) jack (22)
- 5** LINE OUT (R-AUDIO-L/VIDEO) jacks (14, 16)
- 6** LINE OUT (S VIDEO) jack (14)
- 7** COMPONENT VIDEO OUT (Y, P_B/C_B, P_R/C_R) jacks (14)
- 8** AC IN terminal (17)

Glossary

Chapter (page 52)

Sections of a picture or a music feature that are smaller than titles. A title is composed of several chapters. Depending on the disc, no chapters may be recorded.

Copy protection signals (page 37)

Copy restriction set by copyright owners, etc. These signals are included in some software or TV programmes and restrict recording on this recorder.

Dolby Digital (page 75)

Digital audio compression technology developed by Dolby Laboratories. This technology conforms to multi-channel surround sound. The rear channel is stereo and there is a discrete subwoofer channel in this format. Dolby Digital provides the same discrete channels of high quality digital audio found in “Dolby Digital” theater surround sound systems.

Good channel separation is realized because all of the channel data is recorded discretely, and little deterioration occurs because all channel data processing is digital.

DTS (page 75)

Digital audio compression technology by Digital Theater Systems, Inc. This technology conforms to multi-channel surround sound. The rear channel is stereo and there is a discrete subwoofer channel in this format. DTS provides the same discrete channels of high quality digital audio.

Good channel separation is realized because all of the channel data is recorded discretely, and little deterioration occurs because all channel data processing is digital.

DVD+R (page 8)

A DVD+R (read “plus R”) is a recordable disc that is the same size as a DVD VIDEO. Contents can be recorded only once to a DVD+R, and will have the same format as a DVD VIDEO.

DVD+RW (page 8)

A DVD+RW (read “plus RW”) is a recordable and rewritable disc. DVD+RWs use a recording format that is comparable to the DVD VIDEO format.

DVD-R (page 8)

A DVD-R is a recordable disc that is the same size as a DVD VIDEO. Contents can be recorded only once to a DVD-R, and will have the same format as a DVD VIDEO.

DVD-RW (page 8)

A DVD-RW is a recordable and rewritable disc that is the same size as a DVD VIDEO. The DVD-RW has two different modes: VR mode and Video mode. DVDs created in Video mode have the same format as a DVD VIDEO, while discs created in VR (Video Recording) mode allow the contents to be programmed or edited.

DVD VIDEO (page 10)

A disc that contains up to eight hours of moving pictures on a disc the same diameter as a CD. The data capacity of a single-layer and single-sided DVD is 4.7 GB (Giga Byte), which is 7 times that of a CD. The data capacity of a double-layer and single-sided DVD is 8.5 GB, a single-layer and double-sided DVD is 9.4 GB, and double-layer and double-sided DVD is 17 GB. The picture data uses the MPEG 2 format, which is a worldwide standard of digital compression technology. The picture data is compressed to about 1/40 (average) of its original size. The DVD also uses a variable rate coding technology that changes the data to be allocated according to the status of the picture. Audio information is recorded in a multi-channel format, such as Dolby Digital, allowing you to enjoy a more real audio presence.

Furthermore, various advanced functions such as the multi-angle, multilingual, and Parental Control functions are provided on the DVD.

Interlace format (page 15)

Interlace format shows every other line of an image as a single “field” and is the standard method for displaying images on television. The even number field shows the even numbered lines of an image, and the odd numbered field shows the odd numbered lines of an image.

MPEG Audio (page 75)

International standard coding system used to compress audio digital signals authorized by ISO/IEC. MPEG 2, used on DVDs, conforms to up to 7.1-channel surround.

Original (page 57)

Titles actually recorded on a DVD-RW (VR mode). Erasing original titles frees up disc space.

Playlist (page 57)

Playback information created from the actual recordings on a DVD-RW (VR mode). A Playlist leaves the original titles as they are, and contains only the information needed to control playback. A Playlist title takes up very little disc space.

Progressive format (page 15)

Compared to the Interlace format that alternately shows every other line of an image (field) to create one frame, the Progressive format shows the entire image at once as a single frame. This means that while the Interlace format can show 25-30 frames/50-60 fields in one second, the Progressive format can show 50/60 frames in one second. The overall picture quality increases and still images, text, and horizontal lines appear sharper.

Title (page 52)

The longest section of a picture or music feature on a DVD, movie, etc., in video software, or the entire album in audio software.

Track (page 52)

Sections of a music feature on a CD/VIDEO CD (the length of a song).

Language Code List

For details, see page 72.

The language spellings conform to the ISO 639: 1988 (E/F) standard.

Code Language	Code Language	Code Language	Code Language
1027 Afar	1183 Irish	1347 Maori	1507 Samoan
1028 Abkhazian	1186 Scots Gaelic	1349 Macedonian	1508 Shona
1032 Afrikaans	1194 Galician	1350 Malayalam	1509 Somali
1039 Amharic	1196 Guarani	1352 Mongolian	1511 Albanian
1044 Arabic	1203 Gujarati	1353 Moldavian	1512 Serbian
1045 Assamese	1209 Hausa	1356 Marathi	1513 Siswati
1051 Aymara	1217 Hindi	1357 Malay	1514 Sesotho
1052 Azerbaijani	1226 Croatian	1358 Maltese	1515 Sundanese
1053 Bashkir	1229 Hungarian	1363 Burmese	1516 Swedish
1057 Byelorussian	1233 Armenian	1365 Nauru	1517 Swahili
1059 Bulgarian	1235 Interlingua	1369 Nepali	1521 Tamil
1060 Bihari	1239 Interlingue	1376 Dutch	1525 Telugu
1061 Bislama	1245 Inupiak	1379 Norwegian	1527 Tajik
1066 Bengali;	1248 Indonesian	1393 Occitan	1528 Thai
Bangla	1253 Icelandic	1403 (Afan)Oromo	1529 Tigrinya
1067 Tibetan	1254 Italian	1408 Oriya	1531 Turkmen
1070 Breton	1257 Hebrew	1417 Punjabi	1532 Tagalog
1079 Catalan	1261 Japanese	1428 Polish	1534 Setswana
1093 Corsican	1269 Yiddish	1435 Pashto;	1535 Tonga
1097 Czech	1283 Javanese	Pushto	1538 Turkish
1103 Welsh	1287 Georgian	1436 Portuguese	1539 Tsonga
1105 Danish	1297 Kazakh	1463 Quechua	1540 Tatar
1109 German	1298 Greenlandic	1481 Rhaeto-	1543 Twi
1130 Bhutani	1299 Cambodian	Romance	1557 Ukrainian
1142 Greek	1300 Kannada	1482 Kirundi	1564 Urdu
1144 English	1301 Korean	1483 Romanian	1572 Uzbek
1145 Esperanto	1305 Kashmiri	1489 Russian	1581 Vietnamese
1149 Spanish	1307 Kurdish	1491 Kinyarwanda	1587 Volapük
1150 Estonian	1311 Kirghiz	1495 Sanskrit	1613 Wolof
1151 Basque	1313 Latin	1498 Sindhi	1632 Xhosa
1157 Persian	1326 Lingala	1501 Sangho	1665 Yoruba
1165 Finnish	1327 Laothian	1502 Serbo-	1684 Chinese
1166 Fiji	1332 Lithuanian	Croatian	1697 Zulu
1171 Faroese	1334 Latvian;	1503 Singhalese	
1174 French	Lettish	1505 Slovak	
1181 Frisian	1345 Malagasy	1506 Slovenian	1703 Not specified

Area Code

For details, see page 76.

Code Area	Code Area	Code Area	Code Area
2044 Argentina	2165 Finland	2362 Mexico	2149 Spain
2047 Australia	2174 France	2376 Netherlands	2499 Sweden
2046 Austria	2109 Germany	2390 New Zealand	2086 Switzerland
2057 Belgium	2248 India	2379 Norway	2528 Thailand
2070 Brazil	2238 Indonesia	2427 Pakistan	2184 United
2079 Canada	2254 Italy	2424 Philippines	Kingdom
2090 Chile	2276 Japan	2436 Portugal	
2092 China	2304 Korea	2489 Russia	
2115 Denmark	2363 Malaysia	2501 Singapore	

Index

Numerics

- 16:9 21, 72
- 4:3 Letter Box 21, 72
- 4:3 Pan Scan 21, 72
- “48kHz/96kHz PCM” 75

A

- “A-B Erase” 59
- Adjusting
 - playback picture 50
 - playback sound 50
 - recording picture 40
- Aerial 13
- “AFT” 69
- Album 30, 56
- Album number 30
- “Album Search” 52
- Angle 48
- Area code 94
- Audio 48, 74
- “Audio Connection” 21
- Audio cord 16
- “Audio DRC” 74
- “Audio Filter” 51
- “Audio” 72
- “Audio Settings” 50
- “Auto Chapter” 76
- Auto Clock Set 71
- “Auto Display” 78
- “AV SYNC” 51

B

- Batteries 18
- “Bilingual” 44, 45
- Bilingual recording 36
- “BNR” 50
- “Brightness” 41, 50

C

- “C NR” 50
- “Capture All” 61
- “Capture” 61
- “CATV” 68
- CD 10
- “Change IN” 62, 67
- “Change OUT” 62, 67
- “Channel List” 70
- “Channel Setting” 68
- Chapter 30, 41, 61, 92
- CHAPTER MARK 61
- CHAPTER MARK ERASE 61
- Chapter number 30
- “Chapter Search” 52
- Chasing Playback 51
- “Check Overlap” 42
- Checking/changing/
cancelling timer settings
(Timer List) 42
- Child Lock 47
- Cleaning discs 85
- Clock 21, 71
- “Colour” 41, 50
- “Colour System” 77
- Colour Systems 86
- “Combine” 63
- “Command Mode” 20, 79
- Component video input 14
- Connecting 14
 - the aerial cable 13
 - the audio cords 16
 - the video cords 14
- “Contrast” 41, 50
- Controlling TVs with the
remote 18
- Copy control signals 37
- Copy protection 92
- Copy-Free 37
- Copy-Never 37
- Copy-Once 37
- CPRM 8
- “Create Playlist” 61
- Creating chapters 61

D

- DATA CD 10
- “Digital Out” 75
- Digital video camera 64
- “Dimmer” 78
- “Disc Info” 25, 33, 60
- Disc Map 60
- Disc Settings 25, 33, 60, 78
- Disc space 26
- Disc types 8
- Display
 - front panel display 31,
91
- Dolby Digital 16, 75, 92
- “Downmix” 74
- DTS 75, 92
- “Dub Mode” 67
- “DV Audio Input” 65
- DV Dubbing 64
 - One Touch Dubbing 65,
77
 - Program Edit 66
- “DV EDIT” 66
- DV IN 64
- “DVD Bilingual Rec.” 78
- “DVD Menu” 72
- “DVD Rec. Picture Size” 41
- DVD VIDEO 10, 92
- DVD+R 8, 92
- DVD+RW 8, 92
- DVD-R 8, 92
- DVD-RW 8, 92
- DVD-RWs (Video mode) 58
- “DVE” 50

E

- Easy Setup 21, 79
- Editing 57, 61
 - DV Edit 64
- Enter characters 32
- “Erase All” 60
- “Erase” 42, 58, 62, 67
- “Erase Titles” 60
- “Extend Rec” 38

F

“Factory Setup” 79
“Features” 76
“File Search” 52
“Finalize Disc” 77
“Finalize” 35
Finalizing 34, 35
“Format DVD-RW” 78
“Format” 25
Formatting 25
Freeze Frame 49
Front panel 90
Front panel display 31, 91

G

GB 26

H

Handling discs 85
“Hue” 50

I

i.LINK 87
INPUT SELECT 45, 64
Interlace 92
Interlace format 92

J

JPEG image files 53

L

Labelling 33
Language 72
LINE 2 IN 22
“Line Audio Input” 44, 45
LINE IN 1/3 22
“Line Input” 73
“Line1 Input” 73
“Line3 Input” 73

M

Manual Clock Set 71
MENU 46
Menu
 DVD’s Menu 46
 Top menu 46
“Mix” 65
“MNR” 50
“Modify” 42
“Move” 62, 67
MP3 audio tracks 53
MPEG 75, 93

N

NICAM 36, 69
“Normal” 68
Number buttons 33, 39

O

One Touch Dubbing 65, 77
On-screen display
 “OSD” language 21, 72
“Options” 78
Original 29, 57, 93

P

Page mode 29
Parental Control 47, 76
Parts and controls 88
“Pause Mode” 73
“PB Video Equalizer” 50
PBC 46
Picture quality 40, 50
Picture size 40
“Play Beginning” 47
Play mode 30
Playable discs 10

Playback 10, 30, 46, 48
 fast forward 48
 fast reverse 48
 freeze frame 49
 instant advance 48
 instant replay 48
 JPEG image files 53
 MP3 audio tracks 53
 resume play 47
 slow-motion play 49
Playing status bar 30
Playlist 29, 57, 61, 93
Power cord (mains lead) 17
“Power Save” 78
“Preview” 62, 67
Program Edit 66
Progressive 15, 93
“Progressive Mode” 73
“Protect” 58
“Protect Disc” 34
Protection
 disc 33
 title 58

Q

Quick guide to disc types 8
Quick Timer 40

R

Rear panel 91
REC 27
Rec Mode Adjust 38
“Rec Mode” 41
“Rec NR” 41
REC PAUSE 27
“Rec Settings” 41
REC STOP 65
“Rec Video Equalizer” 41
Recordable discs 8

Recording 36, 43, 76
 picture adjustment 40
 recording format 8
 recording mode 27, 36
 recording time 27
 while watching another
 programme 27

Recording time 36
RECOVERY 84
Region code 11
Remaining time 30
Remote 18, 88
Resetting the recorder 79
Resume Play 47

S

S VIDEO 14
Scene List 62
Screen Saver 77
“Search” 52
Searching
 fast reverse/fast forward
 48
 locating the beginning of
 the title/chapter/
 track 48
 search mode 52
 visual search 52
SET 19, 33
“Set Thumbnail” 58
“Settings” 68
ShowView 39
Simultaneous Rec and Play 51
Slow-motion play 49
Sort 29
Sound quality 50
“Station Name” 70
“Stereo1” 65
“Stereo2” 65
Subtitle 48, 72
Super VIDEO CD 10
Surround 48
Synchro Rec 43
“System” 68

T

Teletext 71
Thumbnail picture 29
“Time Search” 52
TIME/TEXT 31
TIMER 38
Timer List 42
Timer recording
 check/change/cancel 42
 manual setting 37
 Rec Mode Adjust 38
 ShowView 39
 Synchro Rec 43
Title 30, 93
TITLE LIST 46
Title List 28, 46
 Sort 29
 Thumbnail 29
“Title Name” 58
Title number 30
“Title Search” 52
TOP MENU 46
Track 93
“Track Search” 52
Troubleshooting 80
Tuner System 21
“TV Guide Page” 71
TV system 68
“TV Type” 21, 72
TV/DVD switch 18
TV/VIDEO 27
TVS (TV Virtual Surround)
48

U

“Unfinalize” 35
Unfinalizing 35
Usable discs 8, 10

V

VIDEO CD 10
Video cord 14
“Video” 72
Video input 14
Video mode 8
“Video Settings” 50
Visual Search 52
VR mode 8, 57

Y

“Y NR” 50

Z

ZWEITON 36



Printed on 100% recycled paper using
VOC (Volatile Organic Compound)-free
vegetable oil based ink.